



SOUTHEASTERN[™] CONFERENCE

BRAND STYLE GUIDE
2021-22

PANTONE 288

PANTONE 122



ON LIGHT



ON DARK



ON BLUE/YELLOW



ON INTERMEDIATE

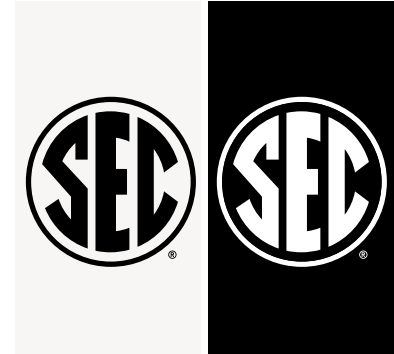

ONE COLOR



ON LIGHT



ON BLUE



SECONDARY LOGOS

SOUTHEASTERN  CONFERENCE®

SOUTHEASTERN  CONFERENCE®

 SOUTHEASTERN
CONFERENCE®

 SOUTHEASTERN
CONFERENCE®

WORD LOGOS



BEVEL LOGOS
(FOR DIGITAL USE ONLY)



PINWHEEL LOGOS



LOGOS & COLOR PALETTE

Use of the SEC identity is restricted to its member institutions and organizations authorized by the SEC. Any other usage is strictly prohibited without the express written consent of the Southeastern Conference.

GOTHAM BLACK

PRIMARY TYPEFACE

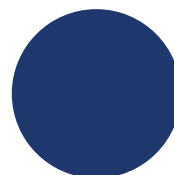

PMS 288
C 100 M 67 Y 0 K 23
MADEIRA THREAD 1167

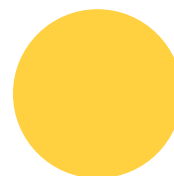

PMS 122
C 0 M 17 Y 80 K 0
MADEIRA THREAD 1171

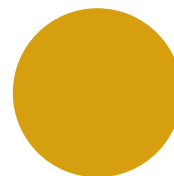

PMS 131
(FOR USE IN BEVELED LOGOS ONLY)
C 0 M 32 Y 100 K 9

COLOR PALETTE



SEC ACADEMIC INITIATIVE LOGOS

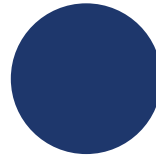

PMS 288
C 100 M 67 Y 0 K 23

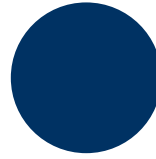

PMS 289
C 100 M 60 Y 0 K 56

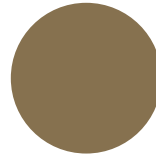

PMS 872
C 43.28 M 47.48 Y 73.23 K 18.34



MEMBER INSTITUTION MARKS REFERENCE GUIDE

ALABAMA

| | | | | |
|---------------------------|--------------------------|------------|-----------------|-----------|
| | | | | |
| ON LIGHT PANTONE 201 C | ON DARK PANTONE 428 C | ON CRIMSON | ON INTERMEDIATE | ONE COLOR |

ARKANSAS

| | | | | |
|---------------------------|--------------------------|------------|-----------------|-----------|
| | | | | |
| ON LIGHT PANTONE 201 C | ON DARK PANTONE 447 C | ON CRIMSON | ON INTERMEDIATE | ONE COLOR |

AUBURN

| | | | | |
|-------------------------|------------------------|-----------|-----------------|-----------|
| | | | | |
| ON LIGHT PANTONE 289 | ON DARK PANTONE 172 | ON ORANGE | ON INTERMEDIATE | ONE COLOR |

FLORIDA

| | | | | |
|---------------------------|--------------------------|---------------------------------|-----------------|-----------|
| | | | | |
| ON LIGHT PANTONE 287 C | ON DARK PANTONE 172 C | ON BLUE/ORANGE PANTONE 349 C | ON INTERMEDIATE | ONE COLOR |

GEORGIA

| | | | | |
|---------------------------|---------|--------|-----------------|-----------|
| | | | | |
| ON LIGHT PANTONE 200 C | ON DARK | ON RED | ON INTERMEDIATE | ONE COLOR |

KENTUCKY

| | | | | |
|---------------------------|--------------------------|---------|-----------------|-----------|
| | | | | |
| ON LIGHT PANTONE 286 C | ON DARK COOL GREY 3 C | ON BLUE | ON INTERMEDIATE | ONE COLOR |

LSU

| | | | | |
|---------------------------|--------------------------|----------------|-----------------|-----------|
| | | | | |
| ON LIGHT PANTONE 268 C | ON DARK PANTONE 123 C | ON PURPLE/GOLD | ON INTERMEDIATE | ONE COLOR |

OLE MISS

| | | | | |
|---------------------------|-------------------------|-------------|-----------------|-----------|
| | | | | |
| ON LIGHT PANTONE 186 C | ON DARK PANTONE 2767 | ON RED/BLUE | ON INTERMEDIATE | ONE COLOR |

MISSISSIPPI ST.

| | | | | |
|---------------------------|--------------------------|-----------|-----------------|-----------|
| | | | | |
| ON LIGHT PANTONE 505 C | ON DARK PANTONE 428 C | ON MAROON | ON INTERMEDIATE | ONE COLOR |

MISSOURI

| | | | | |
|---------------------------|---------|---------|-----------------|-----------|
| | | | | |
| ON LIGHT PANTONE 124 C | ON DARK | ON GOLD | ON INTERMEDIATE | ONE COLOR |

S. CAROLINA

| | | | | |
|---------------------------|---------|-----------|-----------------|-----------|
| | | | | |
| ON LIGHT PANTONE 202 C | ON DARK | ON GARNET | ON INTERMEDIATE | ONE COLOR |

TENNESSEE

| | | | | |
|---------------------------|---------------------------|--------------------------------------|-----------------|-----------|
| | | | | |
| ON LIGHT PANTONE 200 C | ON DARK COOL GRAY 11 C | ON ORANGE MICHIGAN PURPLES BLUE C | ON INTERMEDIATE | ONE COLOR |

TEXAS A&M

| | | | | |
|----------------------------------|--------------------------|-----------|-----------------|-----------|
| | | | | |
| ON LIGHT PANTONE AGGIE MAROON | ON DARK PANTONE 422 C | ON MAROON | ON INTERMEDIATE | ONE COLOR |

VANDERBILT

| | | | | |
|----------------------------|---------|---------|-----------------|-----------|
| | | | | |
| ON LIGHT PANTONE 7502 C | ON DARK | ON GOLD | ON INTERMEDIATE | ONE COLOR |



ONE COLOR
PANTONE 288 PANTONE 122

*Lady Vols mark used only in the following sports: Women's Basketball, Women's Golf, Rowing, Softball, Women's Tennis and Volleyball



INSTITUTIONAL MARKS

ALABAMA

PANTONE 201 C

PANTONE 428 C



ON LIGHT

ON DARK

ON CRIMSON

ON INTERMEDIATE

ONE COLOR



ON LIGHT

ON CRIMSON



INSTITUTIONAL MARKS

ARKANSAS

PANTONE 201 C

PANTONE 447 C

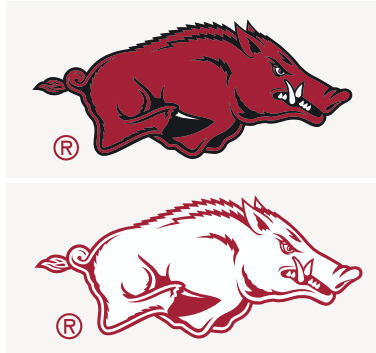

ON LIGHT



ON DARK

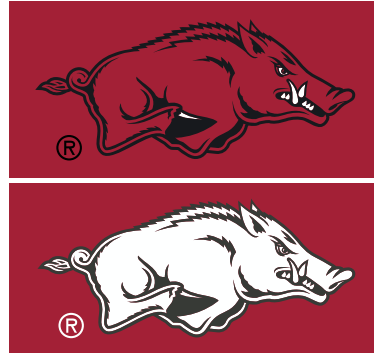

ON CRIMSON

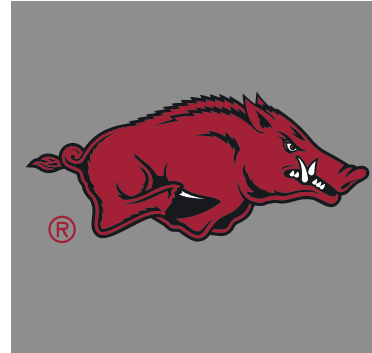

ON INTERMEDIATE

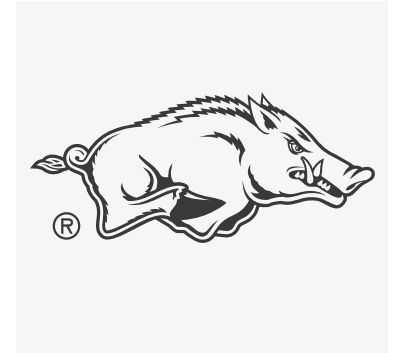

ONE COLOR



ON LIGHT



ON CRIMSON



BASEBALL/SOFTBALL



INSTITUTIONAL MARKS

AUBURN

PANTONE 289

PANTONE 172



ON LIGHT



ON DARK



ON ORANGE



ON INTERMEDIATE

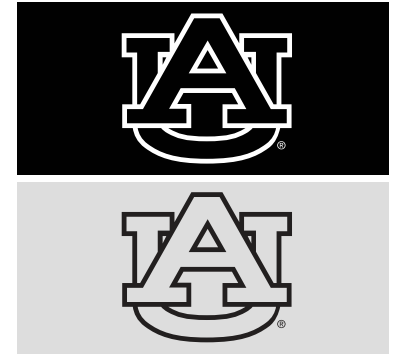

ONE COLOR



ON LIGHT



ON BLUE



INSTITUTIONAL MARKS

FLORIDA

PANTONE 287 C

PANTONE 172 C

PANTONE 349 C



ON LIGHT



ON DARK



ON BLUE/ORANGE



ON INTERMEDIATE



ONE COLOR



ON LIGHT



ON BLUE



BASEBALL



INSTITUTIONAL MARKS

GEORGIA

PANTONE 200 C



ON LIGHT



ON DARK



ON RED



ON INTERMEDIATE



ONE COLOR



ON LIGHT



ON BLACK

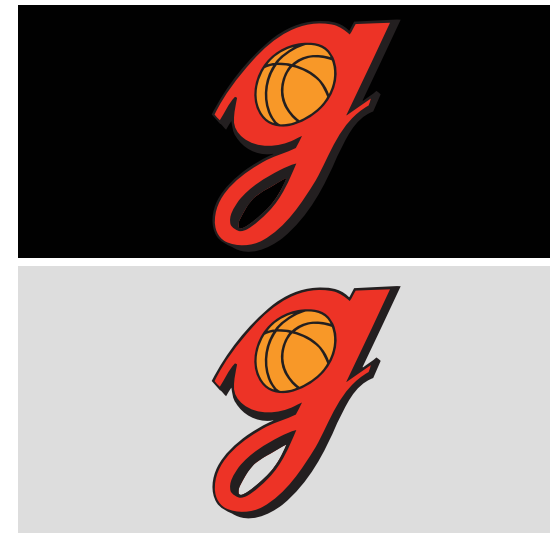

WOMEN'S BASKETBALL



INSTITUTIONAL MARKS

KENTUCKY

PANTONE 286 C

COOL GREY 3 C



ON LIGHT



ON DARK



ON BLUE



ON INTERMEDIATE



ONE COLOR



ON LIGHT



ON BLACK



INSTITUTIONAL MARKS

LSU

PANTONE 268 C

PANTONE 123 C



ON LIGHT/WHITE



ON DARK



ON PURPLE



ON INTERMEDIATE



ONE COLOR



ON LIGHT



ON PURPLE



BASEBALL



INSTITUTIONAL MARKS

OLE MISS

PANTONE 186 C

PANTONE 2767

Ole Miss

Ole Miss

Ole Miss

Ole Miss

Ole Miss

Ole Miss

Ole Miss

Ole Miss

Ole Miss

Ole Miss

Ole Miss

Ole Miss

ON LIGHT

ON DARK

ON RED/BLUE

ON INTERMEDIATE

ONE COLOR



ON LIGHT

ON BLUE



BASEBALL



INSTITUTIONAL MARKS

MISSISSIPPI STATE

PANTONE 505 C

PANTONE 428 C



ON LIGHT



ON DARK



ON MAROON



ON INTERMEDIATE



ONE COLOR



ON LIGHT



ON MAROON



BASEBALL



INSTITUTIONAL MARKS

MISSOURI

PANTONE 124 C



ON LIGHT



ON DARK



ON GOLD



ON INTERMEDIATE



ONE COLOR



ON LIGHT



ON BLACK



BASEBALL



INSTITUTIONAL MARKS

SOUTH CAROLINA

PANTONE 202 C



ON LIGHT



ON DARK



ON GARNET



ON INTERMEDIATE



ONE COLOR



ON LIGHT



ON BLACK



BASEBALL/SOFTBALL



INSTITUTIONAL MARKS

TENNESSEE

PANTONE 151 C

COOL GRAY 11 C

PANTONE PROCESS BLUE C

*Lady Vols mark used only in the following sports: Women's Basketball, Women's Golf, Rowing, Softball, Women's Tennis and Volleyball



ON LIGHT



ON DARK

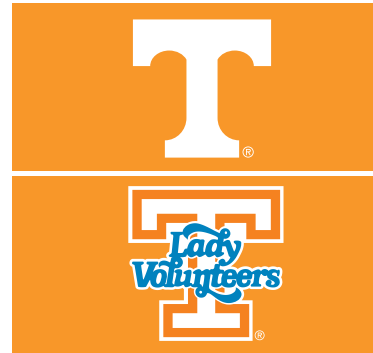

ON ORANGE

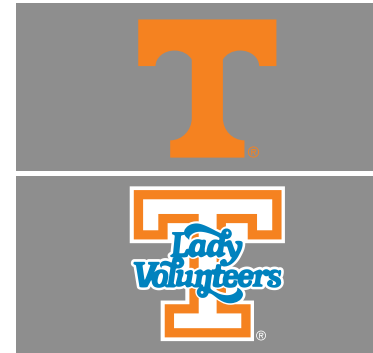

ON INTERMEDIATE

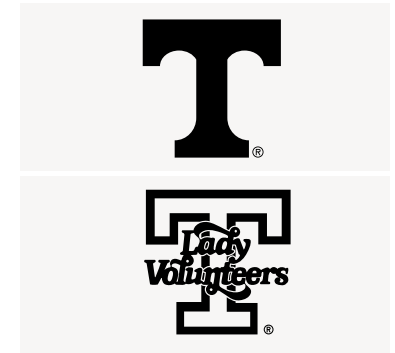

ONE COLOR



ON LIGHT



ON ORANGE



INSTITUTIONAL MARKS

TEXAS A&M

PANTONE AGGIE MAROON

PANTONE 422 C



ON LIGHT

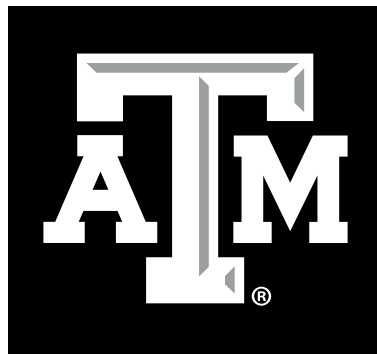

ON DARK

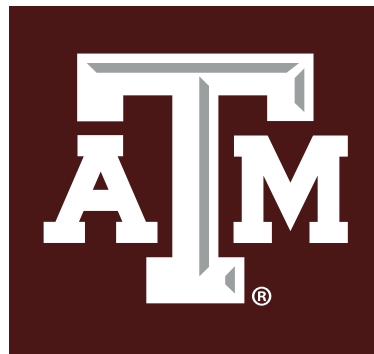

ON MAROON



ON INTERMEDIATE

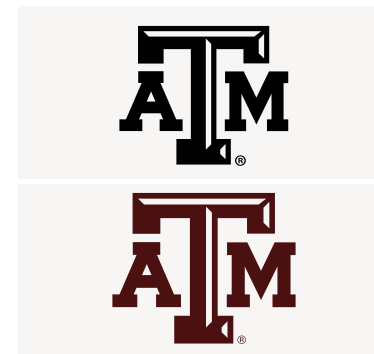

ONE COLOR



ON LIGHT



ON MAROON



INSTITUTIONAL MARKS

VANDERBILT

PANTONE 7502 C



ON LIGHT



ON DARK



ON GOLD



ON INTERMEDIATE

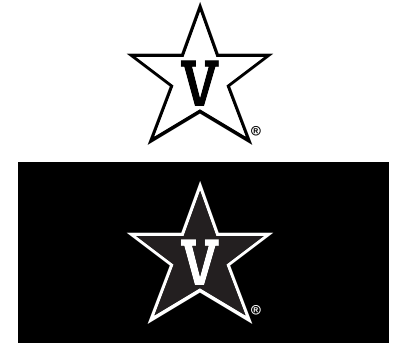

ONE COLOR



ON LIGHT

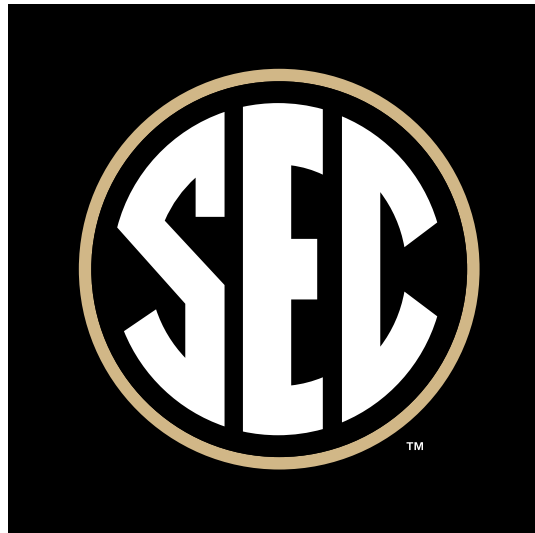

ON BLACK



BASEBALL



SEC NETWORK LOGOS

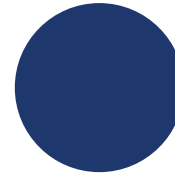

PMS 288
C 100 M 67 Y 0 K 23
MADEIRA THREAD 1167

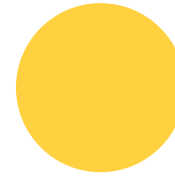

PMS 122
C 0 M 17 Y 80 K 0
MADEIRA THREAD 1171

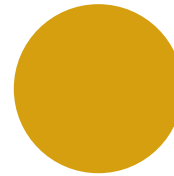

PMS 131
(FOR USE IN BEVELED LOGOS ONLY)
C 0 M 32 Y 100 K 9

COLOR PALETTE

CHAMPIONSHIP MARKS



The 2022 SEC Women's Basketball Tournament and 2022 SEC Gymnastics Championship Logos are in production and will be added once complete.



IT JUST MEANS MORE BRANDING

The font we're using for the tagline as well as branding headlines, is named Brothers. We still plan to use the brand standard Gotham font for non-headline/non-branding type.

The tagline should always have a clear connection to the SEC logo. It is NOT the tagline for any individual school. The SEC logo to use in conjunction with the "It Just Means More" tagline should only be the SEC "lapel pin" logo version and not the primary flat logo.

The linen background must be used in all formats except for merchandise. For "It Just Means More" merchandise approvals, contact the conference office.

BROTHERS

HEADLINE TYPEFACE





UNIFORM & APPAREL PATCH PLACEMENT



SEC UNIFORM PATCHES

This section of the style guide is intended to assist member institutions with placement of the SEC logo patch. Each institution should utilize the SEC uniform patch in its approved school colors. Detailed information about acceptable SEC school color marks, including PMS colors, may be found within this style guide. In some sports, uniform specifications (e.g. material) may dictate that a screen print version of the SEC mark be used in place of the uniform patch. Acceptable instances involving the screen print version of the SEC logo are outlined by sport in the style guide. Please note that while the Conference will supply the uniform patches, it will be the responsibility of each institution to have the mark screen-printed in the designated size and colors. Please note the recommended patch size found on each sport specific page.



SEC GRADUATE PATCH

In each SEC sport, student-athletes who have earned their college degree but are still engaged in competition will wear a specially-designed patch indicating their graduate status.

- The patch will be designed by the SEC Office and distributed by a patch provider designated by the SEC. The design will be similar for all schools, but will be school-specific in color.
- The patch will be worn by any SEC student-athlete upon their first competition following the graduation ceremony at which their degree is awarded, and throughout the remainder of their college eligibility.
- The graduate patch program will be inclusive of graduate transfers to SEC institutions.



UNIFORM & APPAREL PATCH PLACEMENT

SUGGESTED PATCH SIZES BY SPORT

| SPORT | SEC PATCH  | SEC GRADUATE PATCH  |
|--------------------|--|---|
| CROSS COUNTRY | 2.0" x 2.0" | 3.0" x 2.5" |
| SOCCER | 2.0" x 2.0" | 3.0" x 2.5" |
| VOLLEYBALL | 2.0" x 2.0" | 3.0" x 2.5" |
| FOOTBALL* | 2.5" x 2.5" | 3.5" x 3.0" |
| TRACK & FIELD | 2.0" x 2.0" | 3.0" x 2.5" |
| SWIMMING & DIVING | 2.0" x 2.0" | 3.0" x 2.5" |
| EQUESTRIAN | 2.0" x 2.0" | 3.0" x 2.5" |
| WOMEN'S BASKETBALL | 2.5" x 2.5" or 2.0" x 2.0" | 3.0" x 2.5" |
| MEN'S BASKETBALL | 2.5" x 2.5" or 2.0" x 2.0" | 3.0" x 2.5" |
| GYMNASTICS | 2.0" x 2.0" | 3.0" x 2.5" |
| TENNIS | 2.0" x 2.0" | 3.0" x 2.5" |
| GOLF | 2.0" x 2.0" | 3.0" x 2.5" |
| SOFTBALL | 2.5" x 2.5" | 3.5" x 3.0" |
| BASEBALL | 2.5" x 2.5" | 3.5" x 3.0" |

*Institutions who wear the SEC patch on Football jerseys below the collar may utilize the 1.50" or 1.25" patch (2.5" x 2.0" or 2.0" x 1.5" for the Graduate Patch respectively)



UNIFORM & APPAREL PATCH PLACEMENT - CROSS COUNTRY/TRACK & FIELD

Due to varying uniform types for Cross Country/Track & Field, either an SEC uniform patch or SEC full color screen print mark is acceptable and should be done in one of an institution's approved color schemes. Placement options are as follows:

- Front Chest Left
- Front Chest Right
- Front Chest Middle
- Left Front Short
- Right Front Short

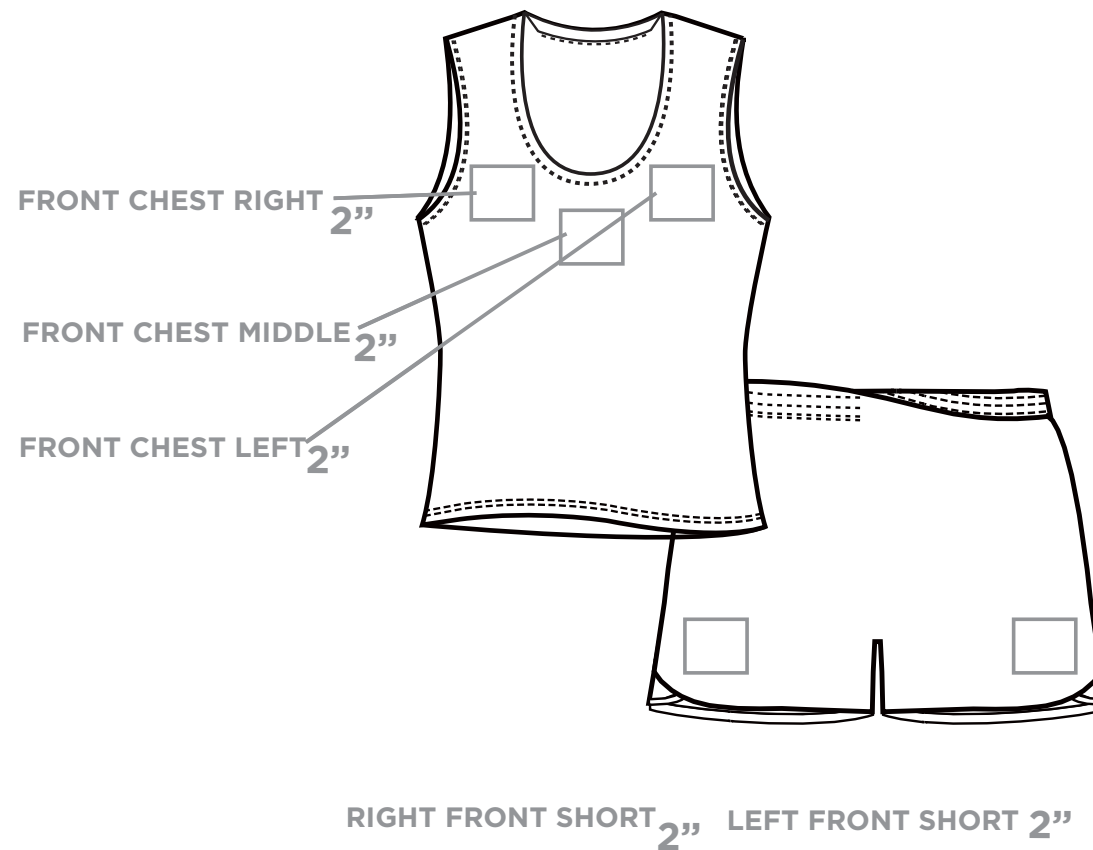



UNIFORM & APPAREL PATCH PLACEMENT - SOCCER

Due to varying uniform types for Soccer, either an SEC uniform patch or SEC full color screen print mark is acceptable and should be done in one of an institution's approved color schemes. Placement options are as follows:

- Front Chest Left
- Front Chest Right
- Front Chest Middle
- Left Sleeve
- Right Sleeve
- Left Front Short
- Right Front Short

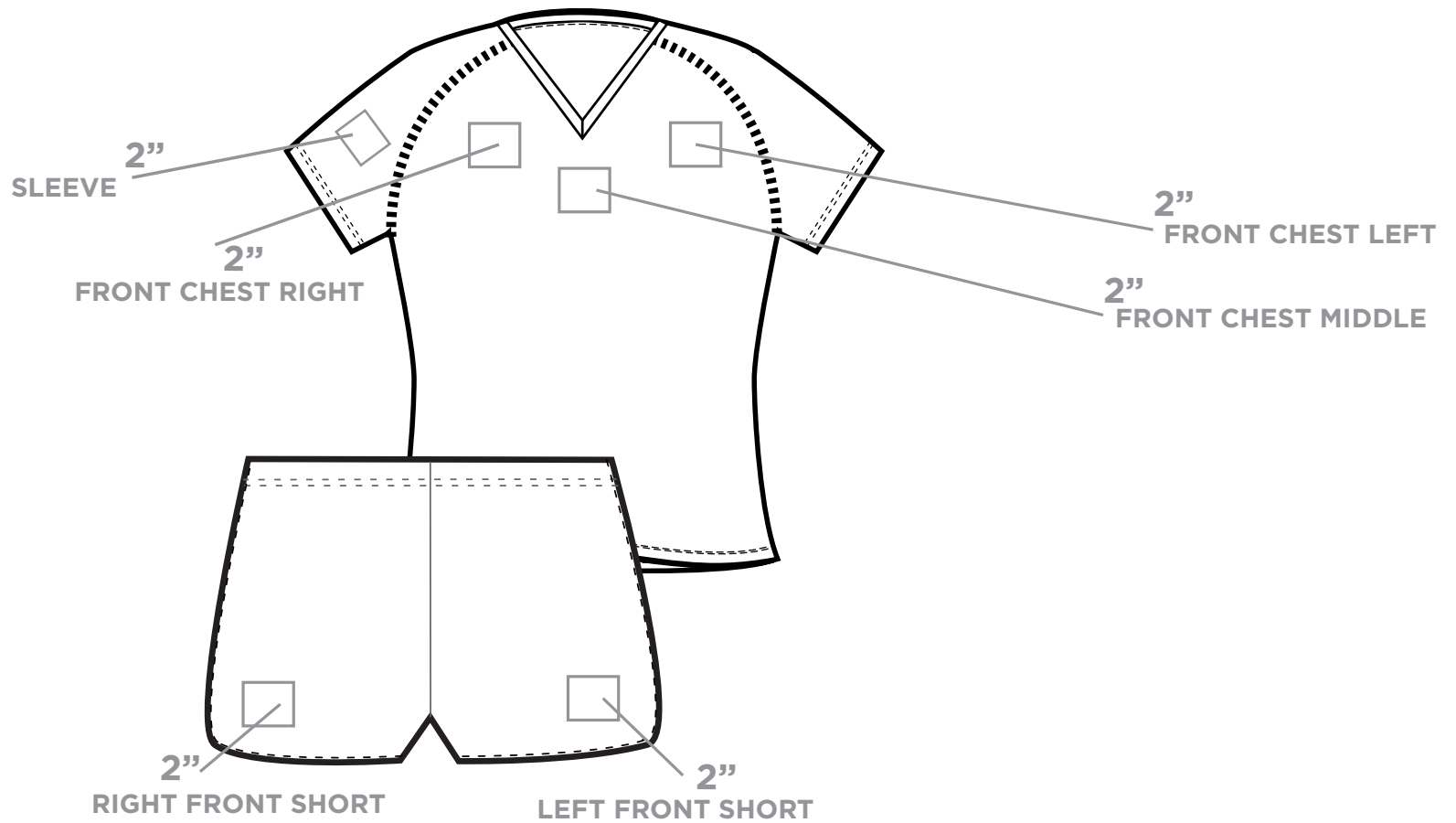



UNIFORM & APPAREL PATCH PLACEMENT - VOLLEYBALL

Due to varying uniform types for Volleyball, either an SEC uniform patch or SEC full color screen print mark is acceptable and should be done in one of an institution's approved color schemes. Placement options are as follows:

- Front Chest Left
- Front Chest Right
- Front Chest Middle
- Left/Right Sleeve
- Left Front Short
- Right Front Short

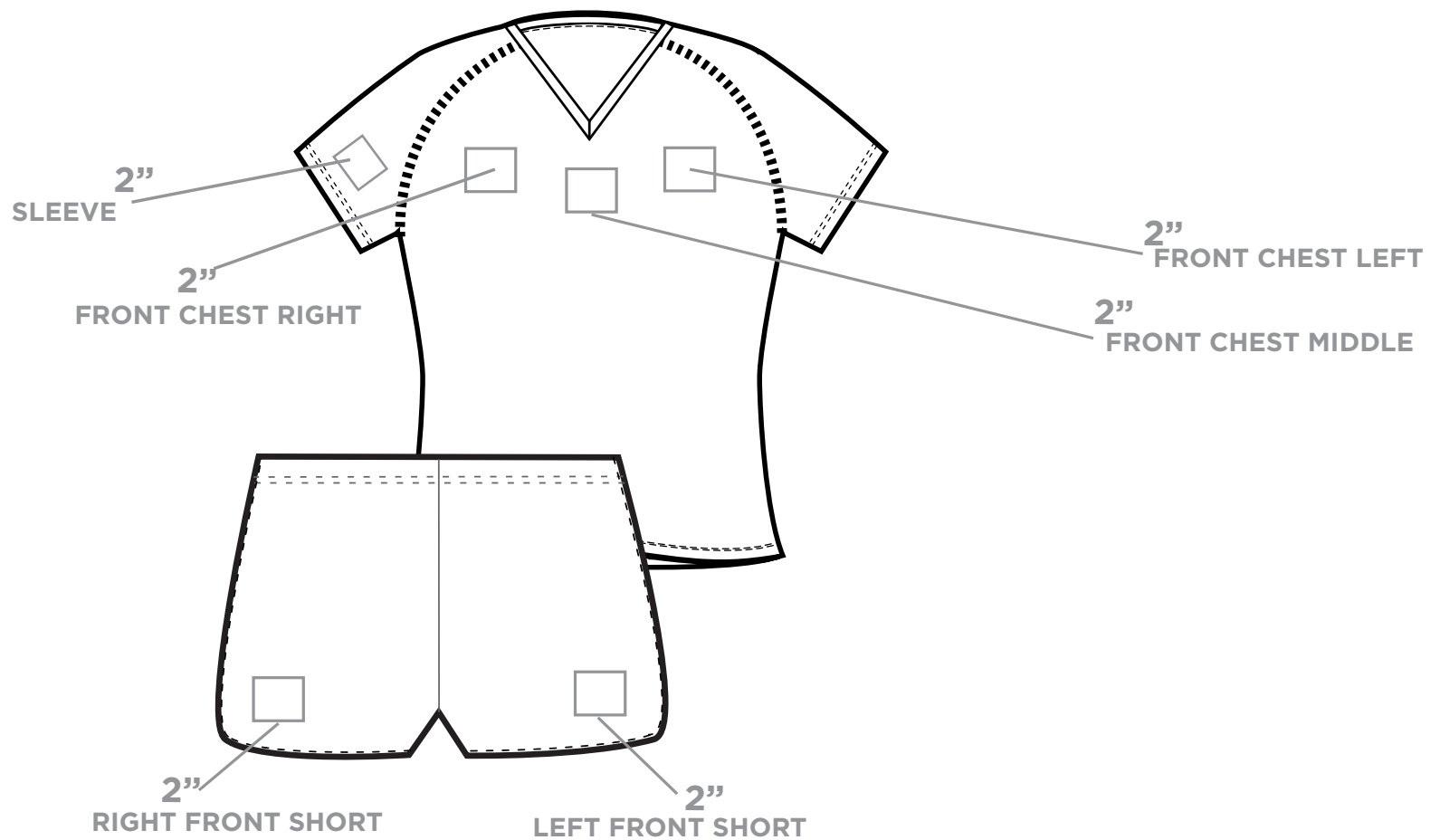



UNIFORM & APPAREL PATCH PLACEMENT - FOOTBALL

The SEC patch shall be used on the front of football jerseys. The size and placement options for the patches are:

1. 2.5" (in diameter) patch placed on the front-left or right upper chest of the jersey.
2. 1.5" or 1.25" (in diameter) patch placed on the front-center collar of the jersey.

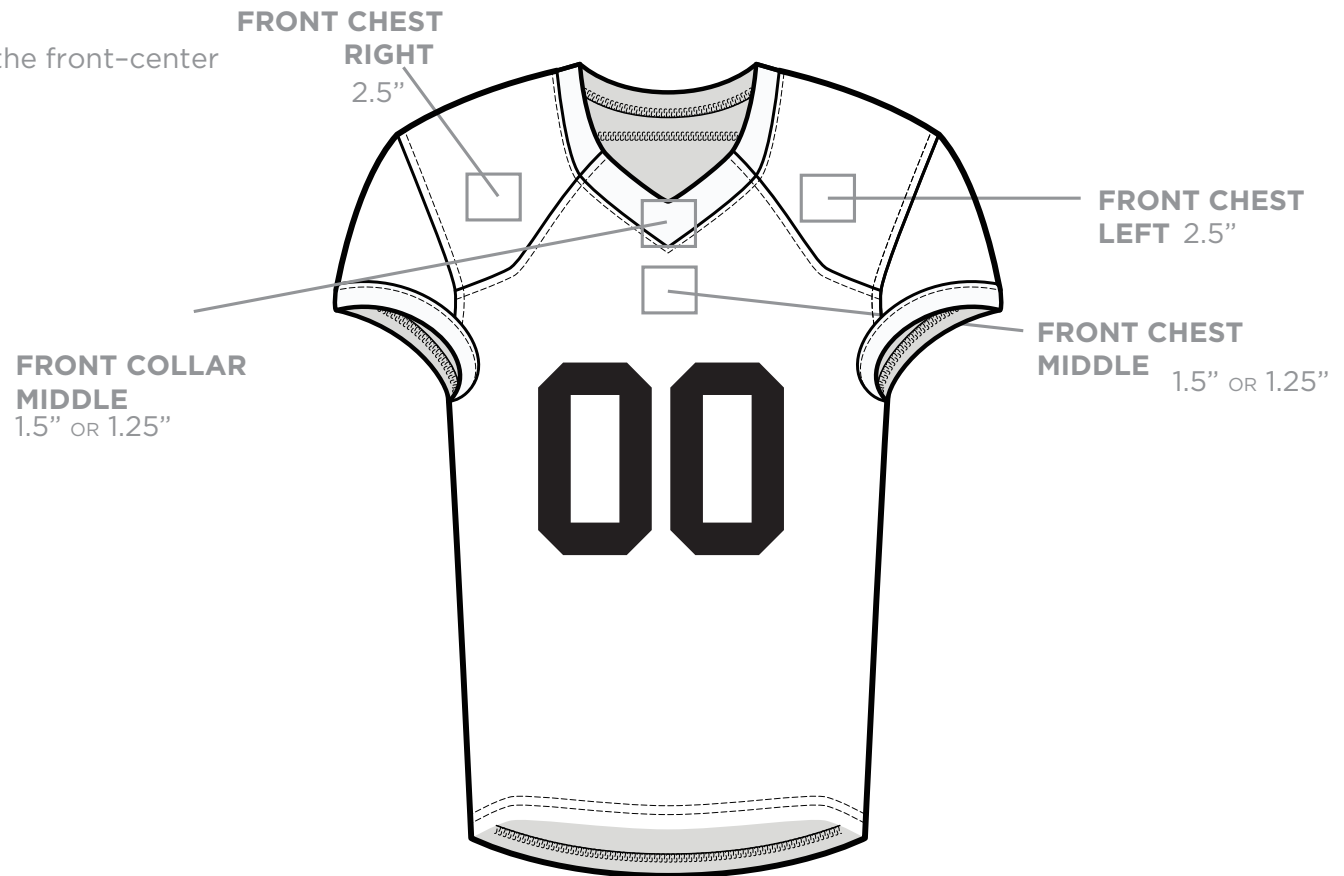



UNIFORM & APPAREL PATCH PLACEMENT - EQUESTRIAN

Due to varying uniform types for Equestrian (Hunt Seat and Western), either the SEC Uniform patch or SEC full color screen print mark is acceptable and should be done in an institution's approved color scheme. Placement options are as follows:

Hunt Seat

- Saddle Pad
- Lapel of Riding Jacket
- Pocket Flap of Riding Jacket
- Helmet

Western

- Saddle Pad
- Shirt Collar
- Back Upper Middle (back tag area)

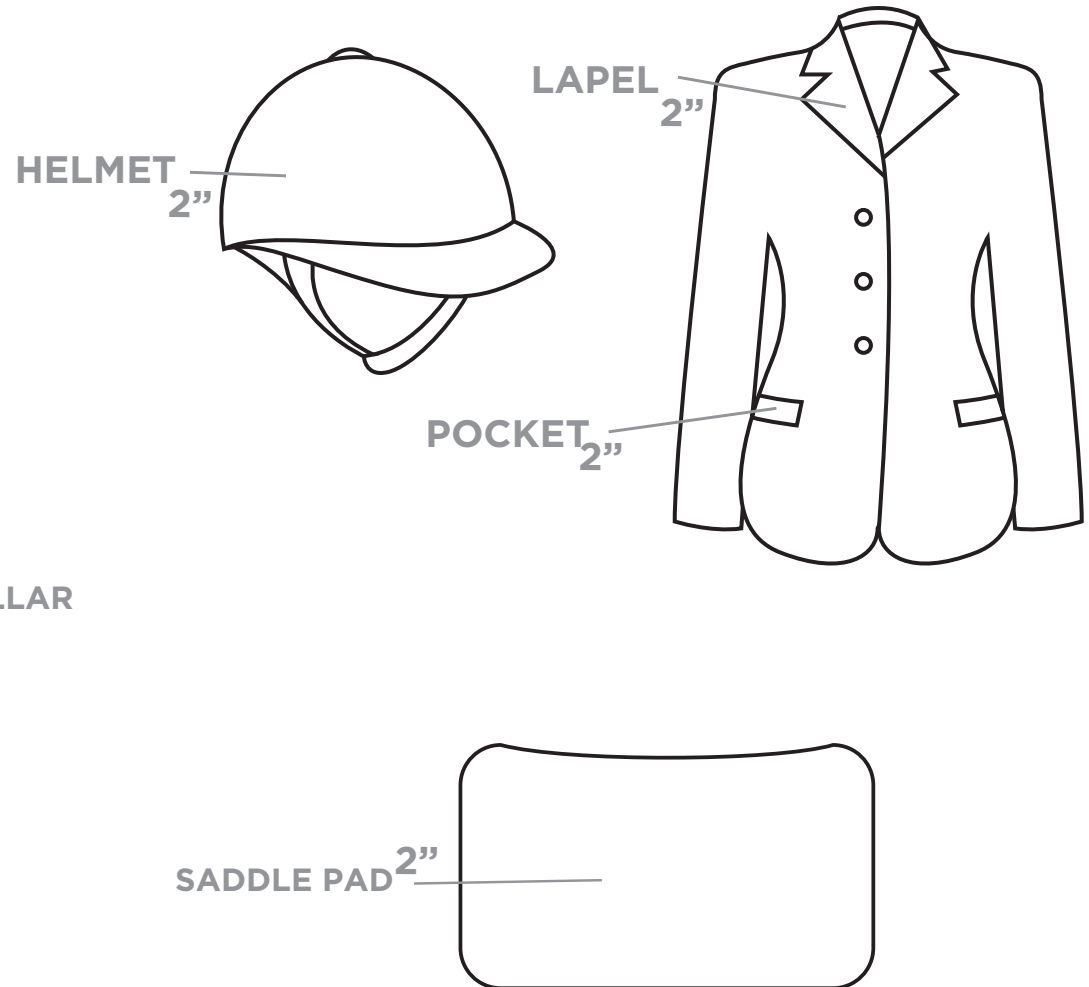
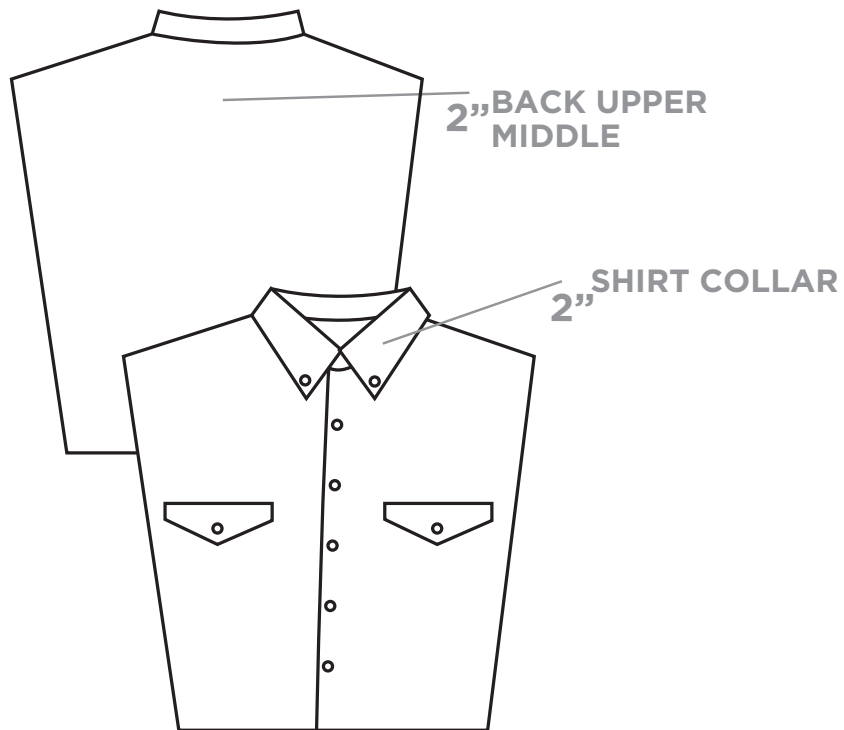



UNIFORM & APPAREL PATCH PLACEMENT - SWIMMING & DIVING

Due to varying uniform types for Swimming & Diving, either an SEC uniform patch or SEC full color screen print mark is acceptable and should be done in one of an institution's approved color schemes. Placement options are as follows:

- Front Swim Cap
- Side(s) Swim Cap
- Back Swim Cap
- Designated Official Warm-up Apparel (including parka)

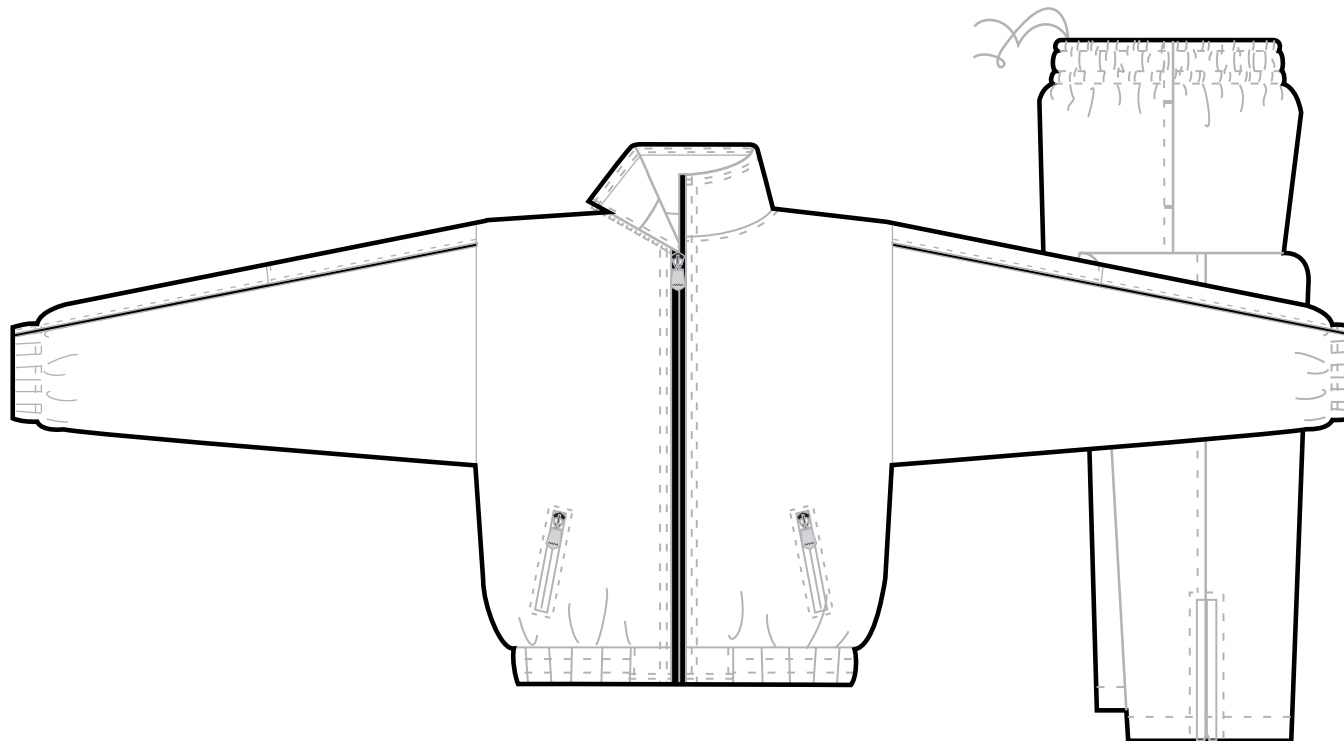

**DESIGNATED OFFICIAL
WARM-UP APPAREL**



UNIFORM & APPAREL PATCH PLACEMENT - BASKETBALL

Uniform patch to be worn on jersey above the number(s). Placement options are as follows:

- Front Chest Left
- Front Chest Right
- Front Chest Middle

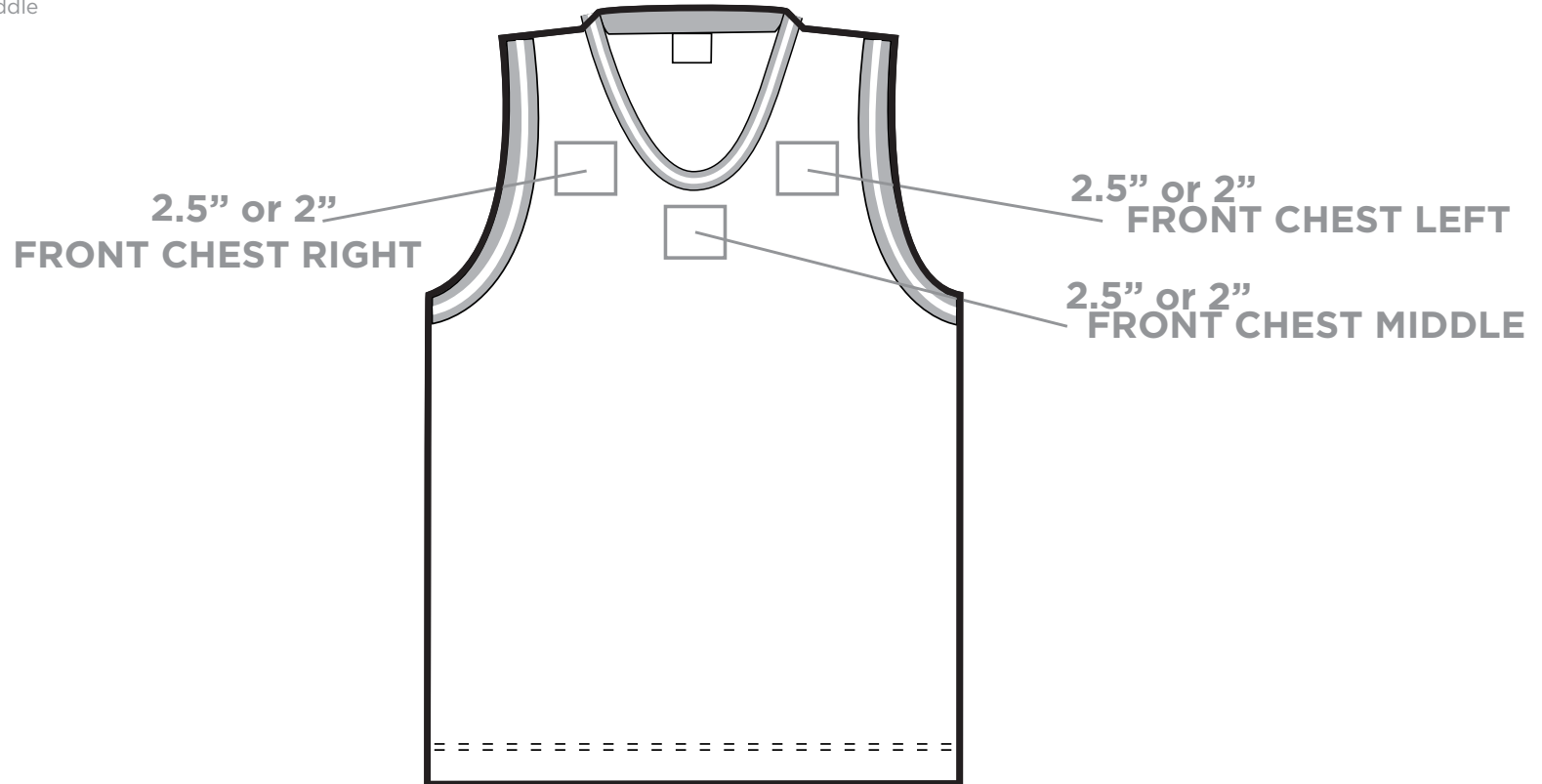

At the 2011 May Basketball Rules Committee Meeting, the NCAA Staff recommended that the current "optional" use of the authentication mark, manufacturers' mark and conference marks continue indefinitely as was in place in 2010-11. The guidelines for placement of the SEC Uniform Patch however remain as set forth in the SEC Brand Style Guide, which calls for the SEC patch to be placed on the front of the basketball jersey, above the numbers, and either on the left, center or right chest of the jersey. It is an institutional decision as to whether the NCAA Basketball patch and/ or manufacturer's marks are included on the uniforms (not required).



UNIFORM & APPAREL PATCH PLACEMENT - GYMNASTICS

Due to varying uniform types for Gymnastics, either an SEC uniform jewelled or bedazzled logo or SEC color screen print mark is acceptable and should be done in one of an institution's approved color schemes. Placement options are as follows:

- Designated Official Warm-up Apparel
- Backpack
- Leotard

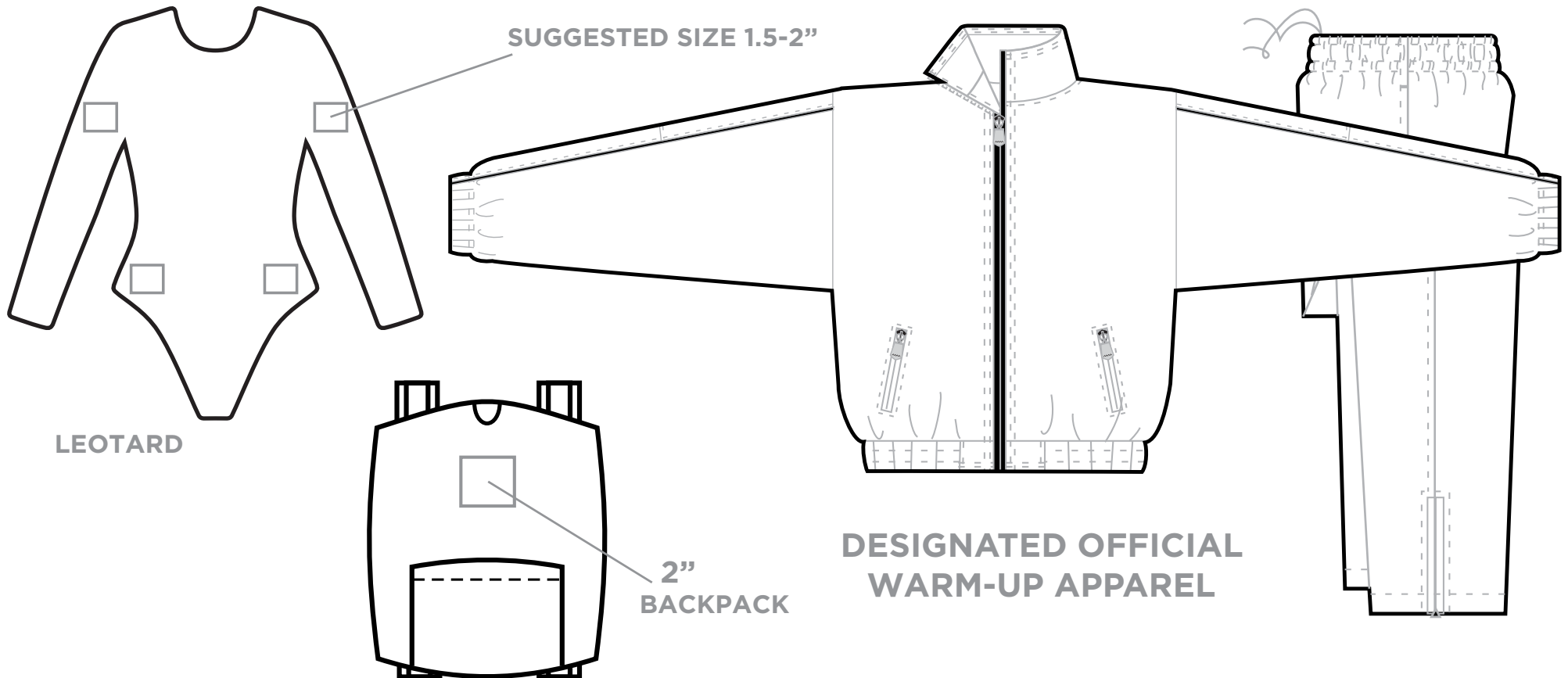



UNIFORM & APPAREL PATCH PLACEMENT - TENNIS

Due to varying uniform types for Tennis, either an SEC uniform patch or SEC full color screen print mark is acceptable and should be done in one of an institution's approved color schemes. Placement options are as follows:

- Left Sleeve
- Right Sleeve
- Left Front Short/Skirt
- Right Front Short/Skirt

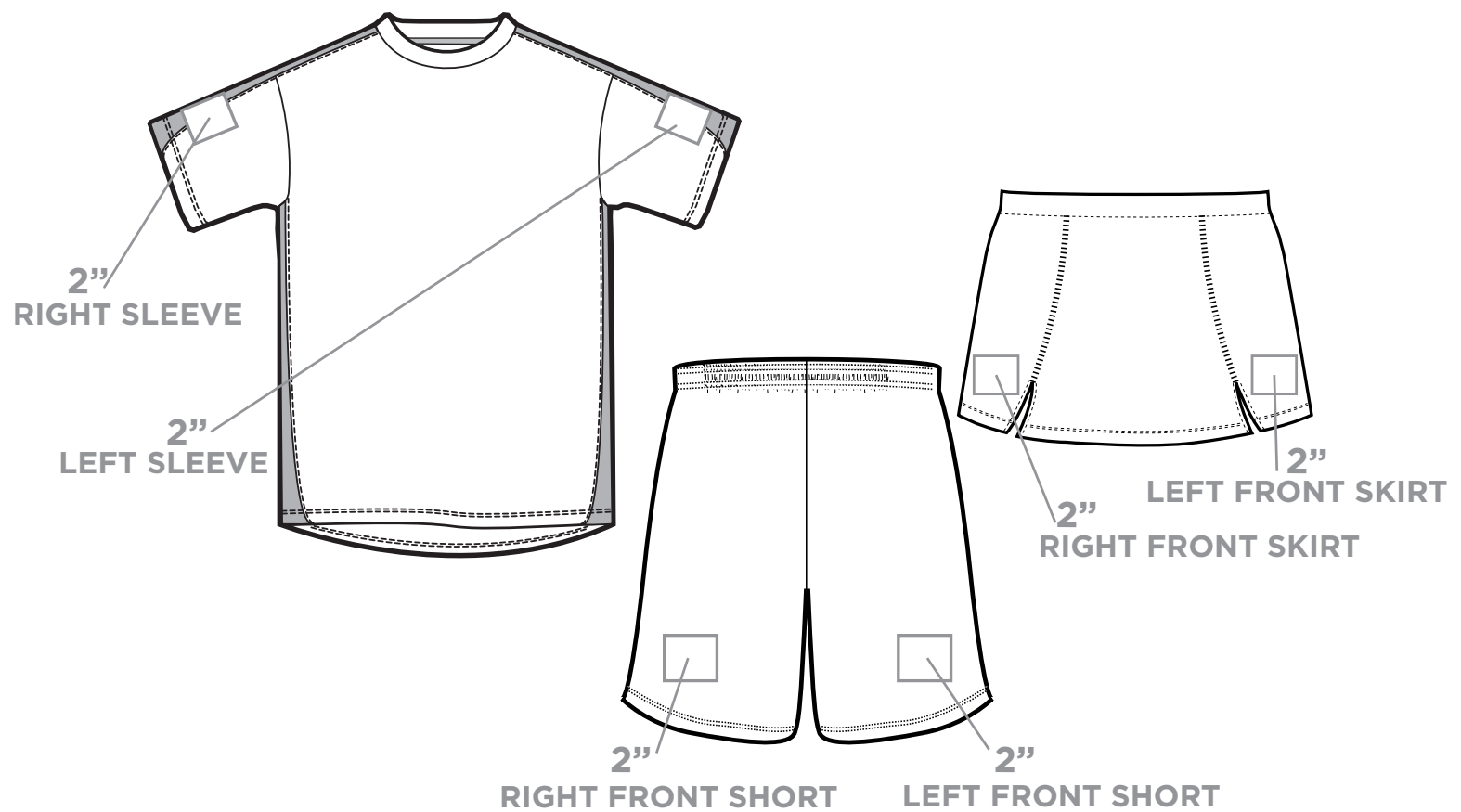



UNIFORM & APPAREL PATCH PLACEMENT - GOLF

Due to varying uniform types for Golf, either an SEC uniform patch or SEC full color screen print mark is acceptable and should be done in one of an institution's approved color schemes. Placement options are as follows:

- Front Chest Left
- Front Chest Right
- Front Chest Middle
- Left Sleeve
- Right Sleeve
- Golf Bag

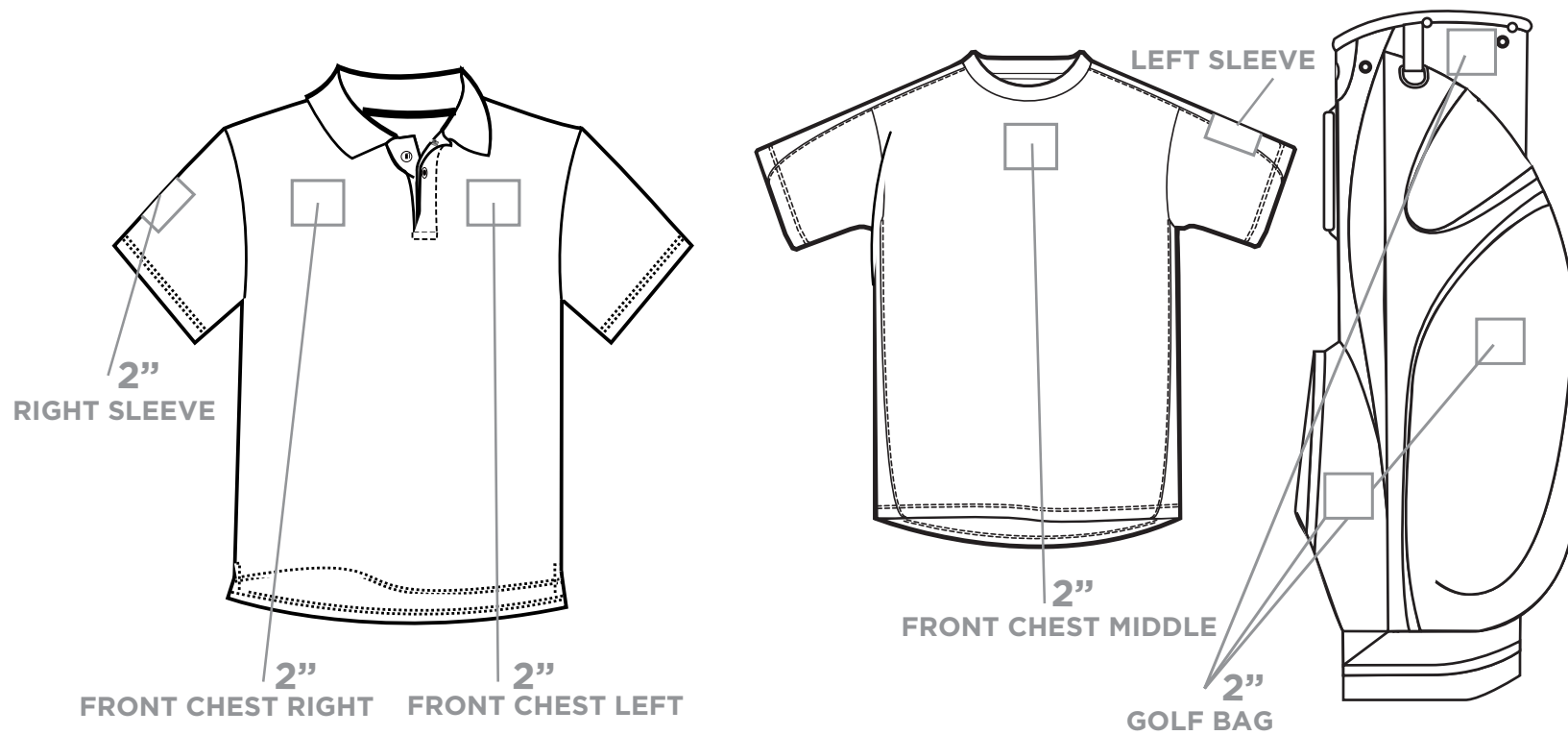



UNIFORM & APPAREL PATCH PLACEMENT - BASEBALL/SOFTBALL

Uniform patch to be worn on jersey. Placement options are as follows:

- Front Chest Left
- Front Chest Right
- Left Sleeve
- Right Sleeve

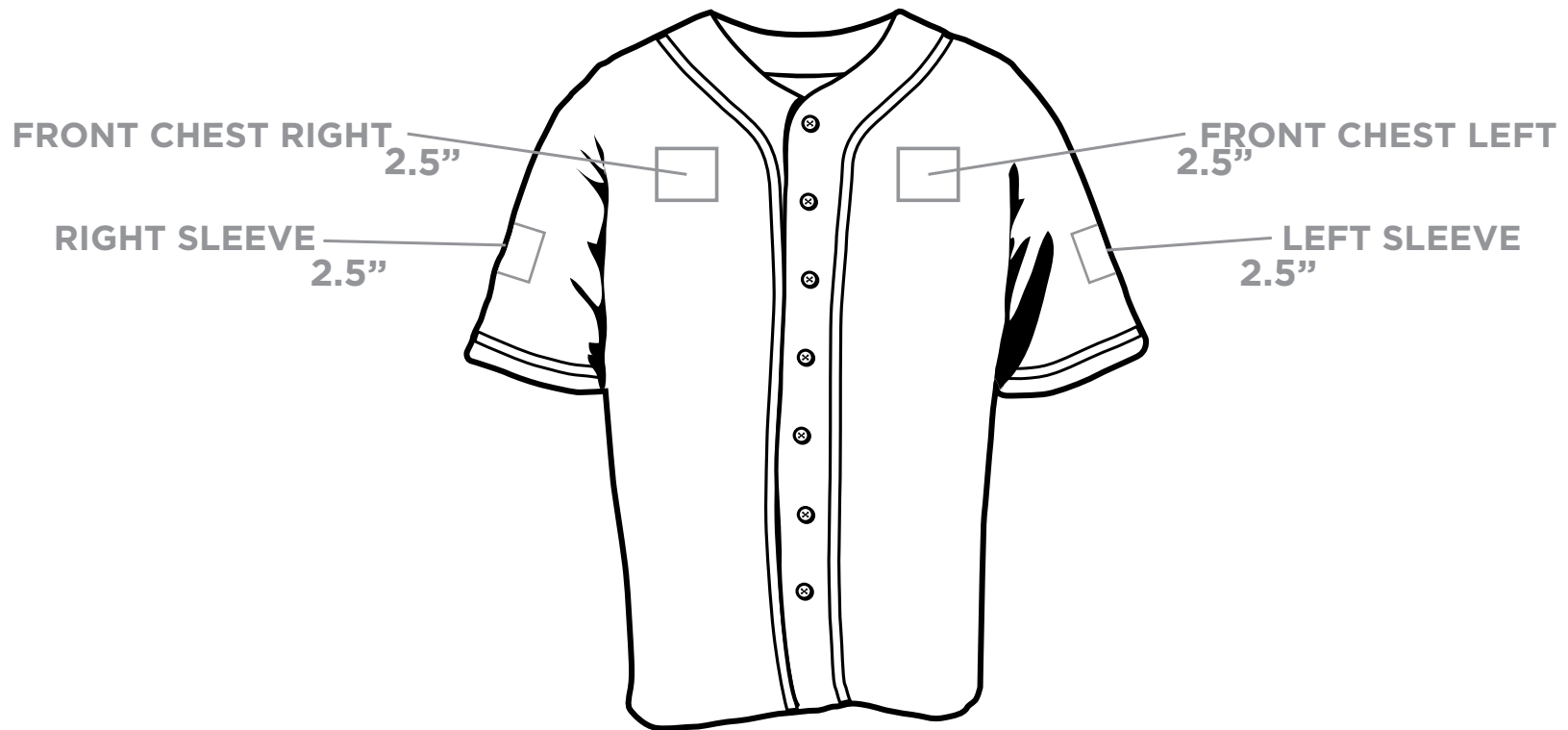



PLAYING SURFACE LOGO PLACEMENT OVERVIEW



This section of the style guide should assist member institutions with placement of the SEC logo on all competition surfaces and in all competition venues. Each institution should utilize the SEC primary logo in its approved school colors. Detailed information about acceptable SEC school color marks, including PMS colors, may be found on page 8 of this style guide.

World Class Athletic Surfaces has previously provided each institution with an SEC logo field stencil (15' x 15') for use in outdoor venues. Each institution should paint the SEC logo (in approved institutional colors) on fields in accordance with the placement guidelines outlined herein. Questions regarding the stencil or paint should be directed to World Class Athletic Surfaces. The contact at World Class Athletic Surfaces is:

Mike Williams
662.210.0035
mike@worldclasspaints.com

CSE Sports can produce SEC signage specific to each institution. Please contact CSE Sports directly with the measurements of any SEC signage needed (signage will be billed to the SEC upon approval). The contact at CSE Sports is:

Rob Thomas
205.908.7446
rthomas@signexp.com



PLAYING SURFACE LOGO PLACEMENT - SOCCER

SOCCER

Logos painted in school approved colors on field.

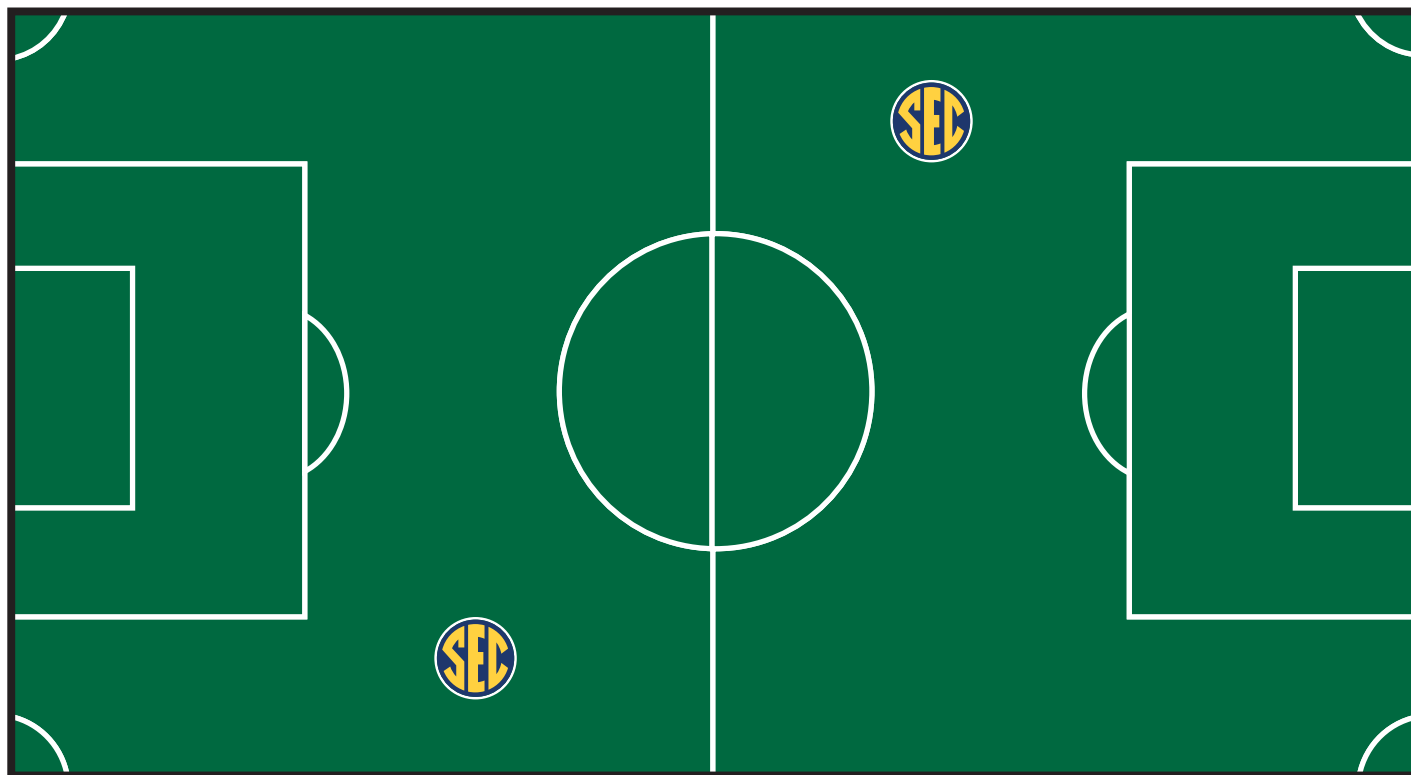



PLAYING SURFACE LOGO PLACEMENT - VOLLEYBALL

VOLLEYBALL

Logos applied in school approved colors on court.

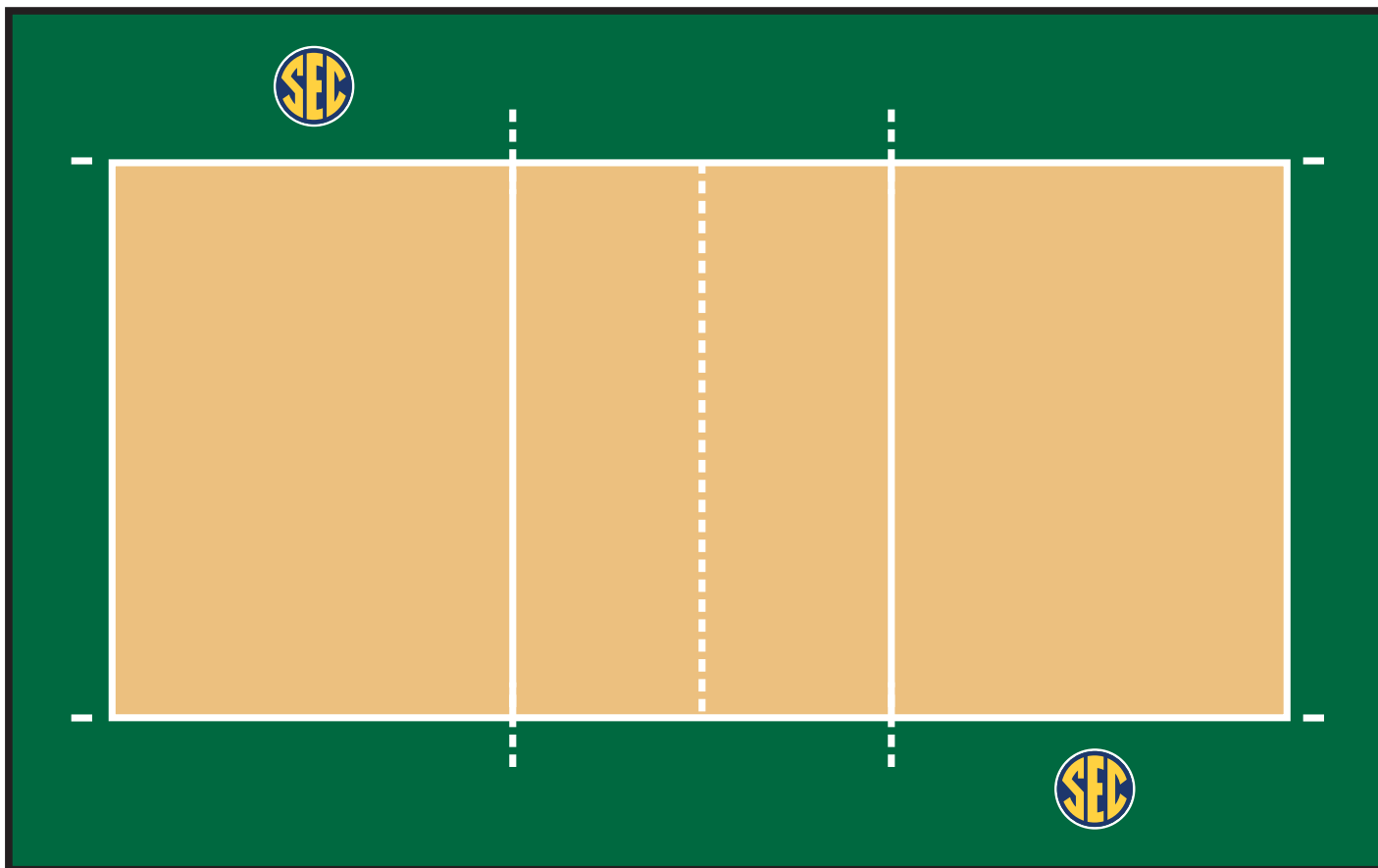



PLAYING SURFACE LOGO PLACEMENT - FOOTBALL

FOOTBALL

Logos painted in school approved colors on field between the numbers and hash marks. The logos should be painted diagonally from each other facing the press box (TV Cameras) on either the 25 or 35 yard line. Please note that any field logo must not completely obliterate a yard line.

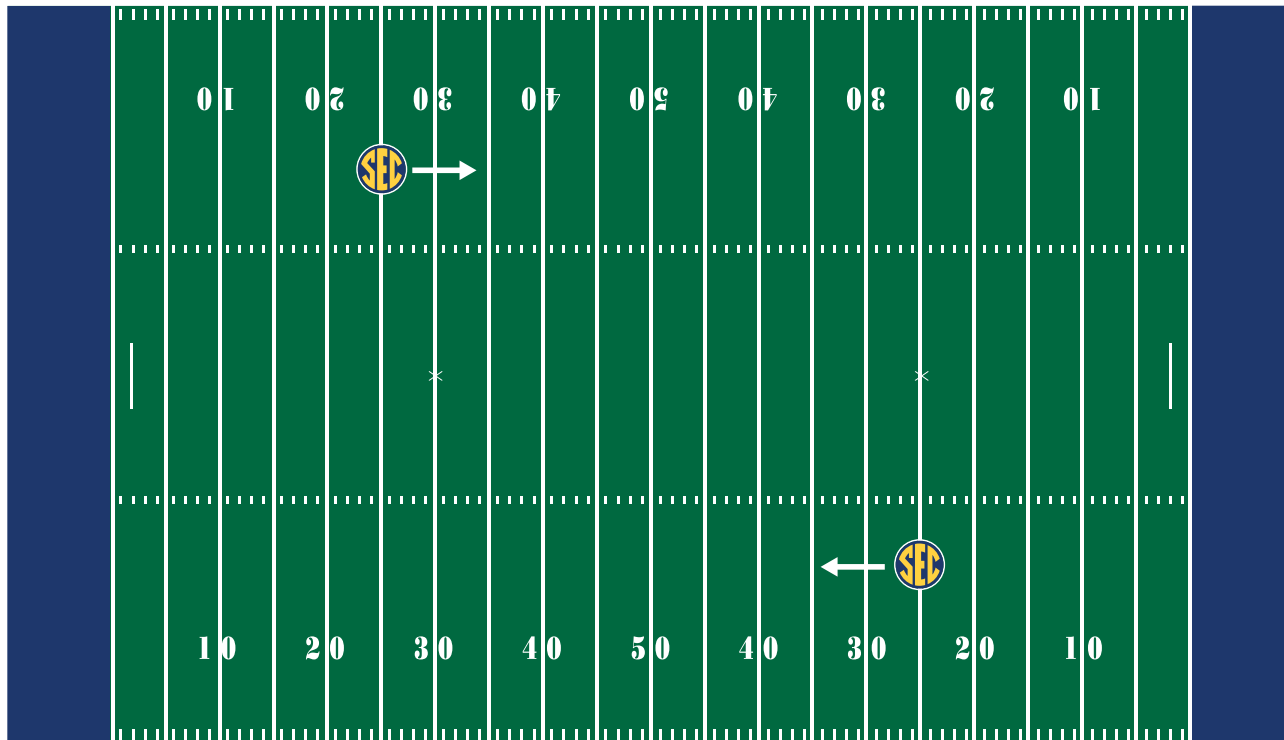

SIDELINE TV CAMERA





PLAYING SURFACE LOGO PLACEMENT - BASKETBALL

BASKETBALL

Logos to be applied in school colors or applicable floor matching color inside both free throw lanes facing the shooter.

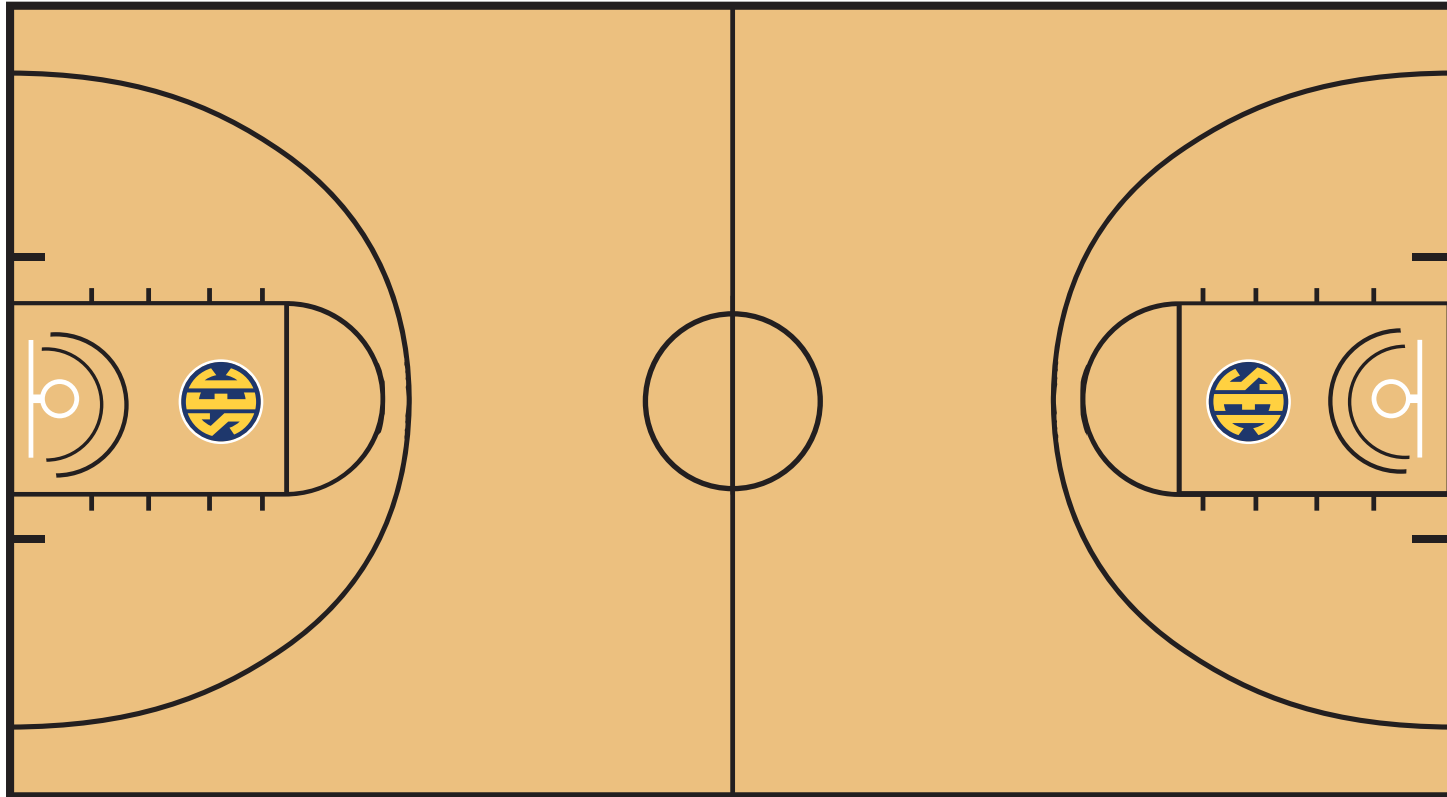



PLAYING SURFACE LOGO PLACEMENT - BASEBALL/SOFTBALL

BASEBALL/SOFTBALL

Logos placed in school approved colors either on field, on backstop padding, or on interior outfield walls.

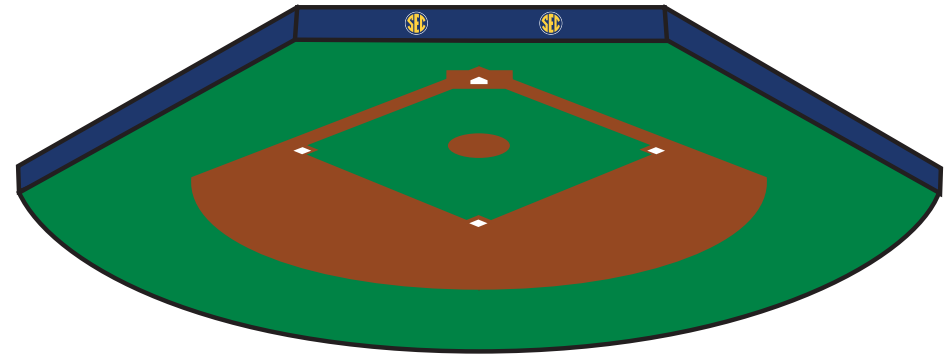
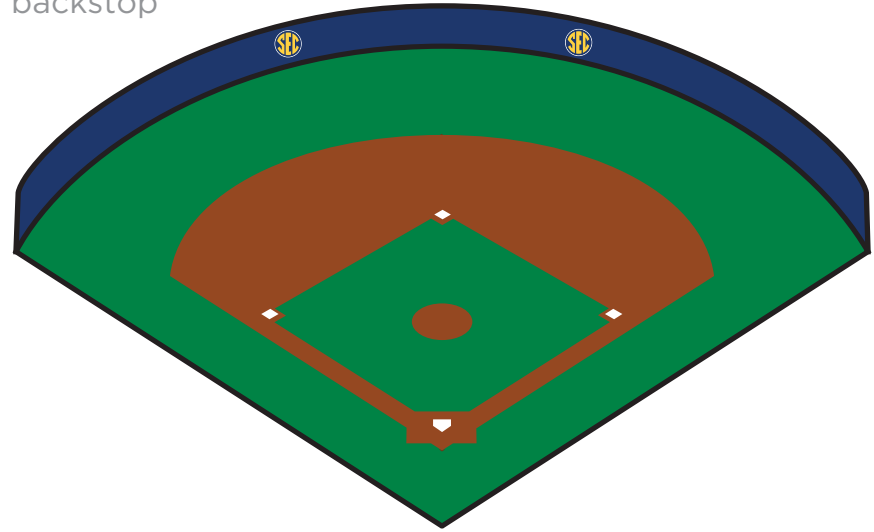
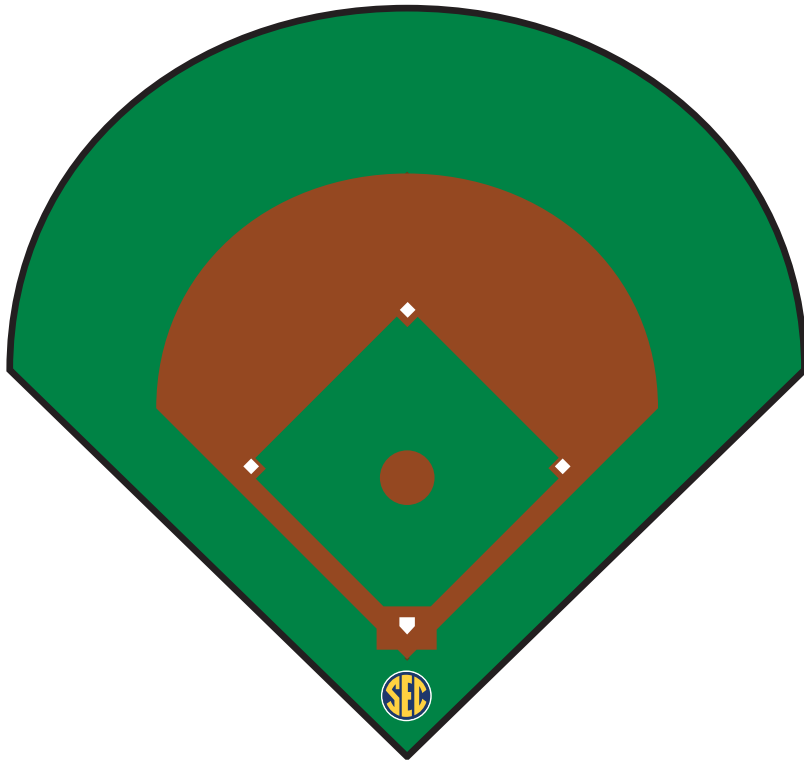



PLAYING SURFACE LOGO PLACEMENT - ALL OTHER SPORTS

CROSS-COUNTRY

- Logo painted in appropriate area (near start and/or finish) or minimum of two banners

EQUESTRIAN

- Logo painted in appropriate area or minimum of two banners in venue

SWIMMING & DIVING

- Minimum of two banners in venue

GYMNASTICS

- Minimum of two banners in venue

GOLF

- Logo painted in appropriate area or minimum of two banners in venue

TENNIS

- Minimum of two banners in venue

TRACK AND FIELD

- Logo painted on infield or minimum of two banners in venue

For questions or additional information regarding the SEC and its marks, please contact Charlie Hussey or B.C. Romano:

Southeastern Conference

2201 Richard Arrington Blvd. North

Birmingham, AL 35203

P 205.458.3000

F 205.458.3031