



SOUTHEASTERN[™] CONFERENCE

BRAND STYLE GUIDE
2020-21

TABLE OF CONTENTS

LOGOS AND COLOR PALETTE	02
IT JUST MEANS MORE BRANDING	04
SEC ACADEMIC INITIATIVE LOGOS	05
SCHOOL LOGOS	06
SEC NETWORK LOGOS	07
SCHOOL SPECIFIC CONFERENCE LOGOS	08
CHAMPIONSHIP MARKS	09
UNIFORM & APPAREL PATCH PLACEMENT	10
CROSS COUNTRY/TRACK & FIELD	11
SOCCER	12
VOLLEYBALL	13
FOOTBALL	14
EQUESTRIAN	15
SWIMMING & DIVING	16
BASKETBALL	17
GYMNASTICS	18
TENNIS	19
GOLF	20
BASEBALL/SOFTBALL	21
PLAYING SURFACE LOGO PLACEMENT OVERVIEW	22
SOCCER	23
VOLLEYBALL	24
FOOTBALL	25
BASKETBALL	26
BASEBALL/SOFTBALL	27
ALL OTHER SPORTS	28

LOGOS & COLOR PALETTE

The Conference encourages institutions to utilize the SEC logo in school colors (see page 8) for these applications. Use of the SEC identity is restricted to its member institutions and organizations authorized by the SEC. Any other usage is strictly prohibited without the express written consent of the Southeastern Conference.

GOTHAM BLACK

PRIMARY TYPEFACE

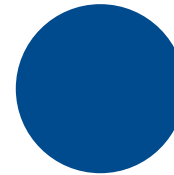

PMS 288
C 100 M 67 Y 0 K 23
MADEIRA THREAD 1167

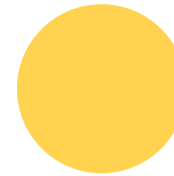

PMS 122
C 0 M 17 Y 80 K 0
MADEIRA THREAD 1171

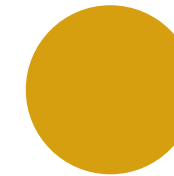

PMS 131
(FOR USE IN BEVELED LOGOS ONLY)
C 0 M 32 Y 100 K 9

COLOR PALETTE

LOGOS & COLOR PALETTE



PRIMARY LOGOS



WORD LOGOS



BEVELED LOGOS

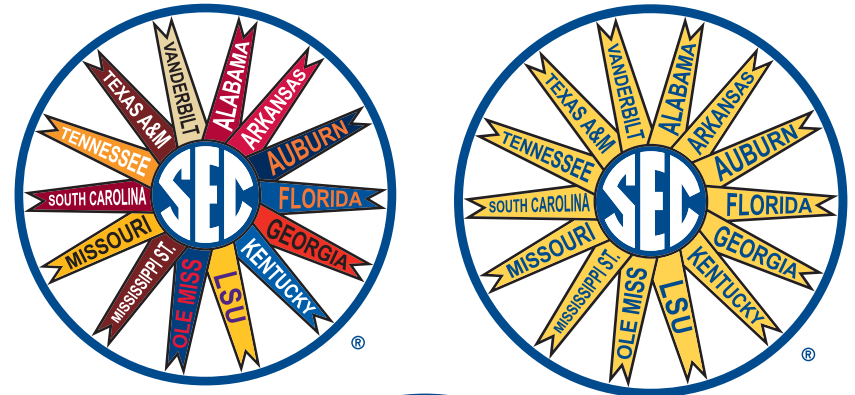

PINWHEEL LOGOS

IT JUST MEANS MORE BRANDING

The font we're using for the tagline as well as branding headlines, is named Brothers. We still plan to use the brand standard Gotham font for non-headline/non-branding type.

The tagline should always have a clear connection to the SEC logo. It is NOT the tagline for any individual school. The SEC logo to use in conjunction with the "It Just Means More" tagline should only be the SEC "lapel pin" logo version and not the primary flat logo.

The linen background must be used in all formats except for merchandise. For "It Just Means More" merchandise approvals, contact the conference office.

BROTHERS

HEADLINE TYPEFACE



SEC ACADEMIC INITIATIVE LOGOS

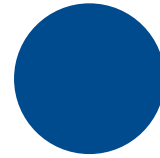

PMS 288
C 100 M 67 Y 0 K 23

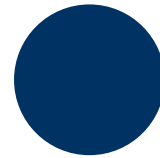

PMS 289
C 100 M 60 Y 0 K 56

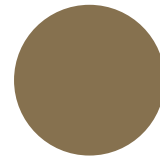

PMS 872
C 43.28 M 47.48 Y 73.23 K 18.34

SCHOOL LOGOS



ALABAMA

CRIMSON: PMS 201 | C:0 M:100
Y:63 K:29 | R:179 G:8 B:56
LIGHT SILVER: PMS 428 | C:2 M:0 Y:0
K:18 | R:207 G:212 B:216
BLACK



ARKANSAS

RED: PMS 201 | C:7 M:100
Y:68 K:32 | R:157 G:34 B:53
BLACK



AUBURN

BLUE: PMS 289 | C:100 M:64
Y:0 K:60 | R:0 G:43 B:92
ORANGE: PMS 172 | C:0 M:75
Y:100 K:0 | R:242 G:101 B:34



FLORIDA

BLUE: PMS 287 | C:100 M:60
Y:0 K:20 | R:0 G:48 B:135
ORANGE: PMS 172 | C:0 M:80
Y:100 K:0 | R:250 G:70 B:22
GREEN: PMS 349 | C:90 M:12
Y:95 K:40 | R:4 G:106 B:56



GEORGIA

RED: PMS 200 | C:16 M:100
Y:87 K:6 | R:195 G:0 B:47
SILVER: PMS 429 | C:38 M:28
Y:27 K:0 | R:93 G:103 B:112
BLACK



KENTUCKY

BLUE: PMS 286 | C:100
M:75 Y:0 K:0 | R:0 G:51 B:60
GRAY: PMS COOL GRAY 3 | C:8
M:5 Y:7 K:16 | R:200 G:201 B:199



LSU

PURPLE: PMS 268 | C:82 M:98
Y:0 K:12 | R:70 G:29 B:124
GOLD: PMS 123 | C:0 M:19 Y:89
K:0 | R:253 G:208 B:35
BLACK



OLE MISS

RED: PMS 186 | C:0 M:100
Y:81 K:4 | R:227 G:24 B:55
BLUE: PMS 281 | C:98.82 M:85.49
Y:42.46 K:42.48 | R:18 G:40
B:73



MISSISSIPPI STATE

MAROON: PMS 505 | C:50 M:100
Y:100 K:25 | R:102 G:0 B:0
GRAY: PMS 428 | C:2 M:0 Y:0
K:18 | R:207 G:212 B:216



MISSOURI

GOLD: PMS 124C | C:0 M:31
Y:98 K:0 | R:241 G:184 B:45
BLACK



SOUTH CAROLINA

GARNET: PMS 202 | C:0 M:100
Y:61.18 K:43.14 | R:152 G:0 B:46
BLACK



TENNESSEE

ORANGE: PMS 151 | C:0 M:60
Y:100 K:0 | R:255 G:130 B:0



TENNESSEE LADY VOLS

ORANGE: PMS 151 | C:0 M:60
Y:100 K:0 | R:255 G:130 B:0
BLUE: PMS PROCESS BLUE
C:100 M:9 Y:0 K:6 | R:0
G:153 B:216



TEXAS A&M

MAROON: PMS AGGIE MAROON
C:15 M:100 Y:39 K:69
R:80 G:0 B:0



VANDERBILT

GOLD: PMS 7502 | C:10 M:25
Y:80 K:0 | R:216 G:171 B:76
BLACK

SEC NETWORK LOGOS

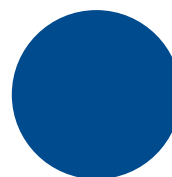

PMS 288
C 100 M 67 Y 0 K 23
MADEIRA THREAD 1167



PMS 122
C 0 M 17 Y 80 K 0
MADEIRA THREAD 1171

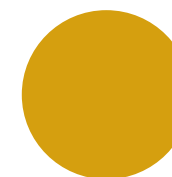

PMS 131
(FOR USE IN BEVELED LOGOS ONLY)
C 0 M 32 Y 100 K 9

COLOR PALETTE

SCHOOL SPECIFIC CONFERENCE LOGOS



ALABAMA
PMS 201 CRIMSON



ARKANSAS
PMS 201 RED



AUBURN
PMS 172 ORANGE
PMS 289 BLUE



FLORIDA
PMS 287 BLUE
PMS 172 ORANGE



GEORGIA
PMS 200 RED
BLACK



KENTUCKY
PMS 286 BLUE



LSU
PMS 268 PURPLE
PMS 123 GOLD



OLE MISS
PMS 186 RED
PMS 281 BLUE



MISSISSIPPI STATE
PMS 505 MAROON
PMS 428 GRAY



MISSOURI
PMS 124C GOLD
BLACK



SOUTH CAROLINA
PMS 202 GARNET
BLACK



TENNESSEE
PMS 151 ORANGE



TEXAS A&M
PMS AGGIE MAROON



VANDERBILT
PMS 7502 GOLD
BLACK

*INVERSE OF SEC SCHOOL COLORS IS PERMISSABLE AS LONG AS THE "SEC" REMAINS WHITE.

CHAMPIONSHIP MARKS





MEMBER INSTITUTION MARKS REFERENCE GUIDE

ALABAMA

ON LIGHT PANTONE 201 C	ON DARK PANTONE 428 C	ON CRIMSON	ON INTERMEDIATE	ONE COLOR

ARKANSAS

ON LIGHT PANTONE 201 C	ON DARK PANTONE 447 C	ON CRIMSON	ON INTERMEDIATE	ONE COLOR

AUBURN

ON LIGHT PANTONE 289	ON DARK PANTONE 172	ON ORANGE	ON INTERMEDIATE	ONE COLOR

FLORIDA

ON LIGHT PANTONE 287 C	ON DARK PANTONE 172 C	ON BLUE/ORANGE PANTONE 349 C	ON INTERMEDIATE	ONE COLOR

GEORGIA

ON LIGHT PANTONE 200 C	ON DARK	ON RED	ON INTERMEDIATE	ONE COLOR

KENTUCKY

ON LIGHT PANTONE 286 C	ON DARK COOL GREY 3 C	ON BLUE	ON INTERMEDIATE	ONE COLOR

LSU

ON LIGHT PANTONE 268 C	ON DARK PANTONE 123 C	ON PURPLE/GOLD	ON INTERMEDIATE	ONE COLOR

OLE MISS

ON LIGHT PANTONE 186 C	ON DARK PANTONE 281 C	ON RED/BLUE	ON INTERMEDIATE	ONE COLOR

MISSISSIPPI ST.

ON LIGHT PANTONE 505 C	ON DARK PANTONE 428 C	ON MAROON	ON INTERMEDIATE	ONE COLOR

MISSOURI

ON LIGHT PANTONE 124 C	ON DARK	ON GOLD	ON INTERMEDIATE	ONE COLOR

S. CAROLINA

ON LIGHT PANTONE 202 C	ON DARK	ON GARNET	ON INTERMEDIATE	ONE COLOR

TENNESSEE

ON LIGHT PANTONE 200 C	ON DARK COOL GRAY 11 C	ON ORANGE MICHIGAN PEARLS BLUE C	ON INTERMEDIATE	ONE COLOR

TEXAS A&M

ON LIGHT PANTONE AGGIE MAROON	ON DARK PANTONE 422 C	ON MAROON	ON INTERMEDIATE	ONE COLOR

VANDERBILT

ON LIGHT PANTONE 7502 C	ON DARK	ON GOLD	ON INTERMEDIATE	ONE COLOR



PANTONE 288 PANTONE 122

*Lady Vols mark used only in the following sports: Women's Basketball, Women's Golf, Rowing, Softball, Women's Tennis and Volleyball

UNIFORM & APPAREL PATCH PLACEMENT

This section of the style guide is intended to assist member institutions with placement of the SEC logo patch. Each institution should utilize the SEC uniform patch in its approved school colors. Detailed information about acceptable SEC school color marks, including PMS colors, may be found on page 8 of this style guide. In some sports, uniform specifications (e.g. material) may dictate that a screen print version of the SEC mark be used in place of the uniform patch. Acceptable instances involving the screen print version of the SEC logo are outlined by sport in the style guide. Please note that while the Conference will supply the uniform patches, it will be the responsibility of each institution to have the mark screen-printed in the designated size and colors. For the sport of football, please note the acceptable patch sizes. (pg. 13)

SEC GRADUATE PATCH

In each SEC sport, student-athletes who have earned their college degree but are still engaged in competition will wear a specially-designed patch indicating their graduate status.

- The patch will be designed by the SEC Office and distributed by a patch provider designated by the SEC. The design will be similar for all schools, but will be school-specific in color.
- The patch will be worn by any SEC student-athlete upon their first competition following the graduation ceremony at which their degree is awarded, and throughout the remainder of their college eligibility.
- The graduate patch program will be inclusive of graduate transfers to SEC institutions.

UNIFORM PATCH SPECS

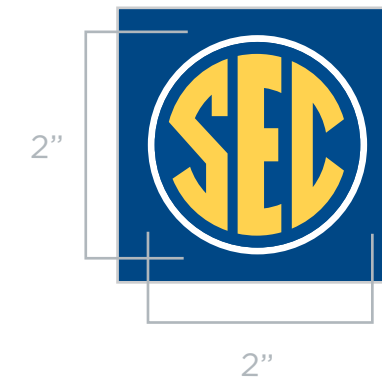
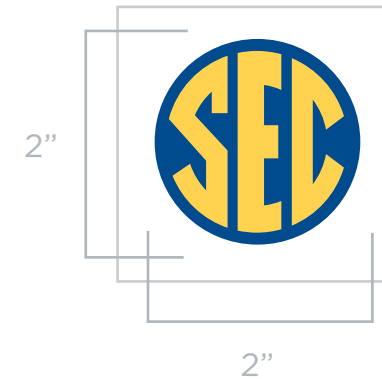

UNIFORM & APPAREL PATCH PLACEMENT - CROSS COUNTRY/TRACK & FIELD

Due to varying uniform types for Cross Country/Track & Field, either an SEC uniform patch or SEC full color screen print mark is acceptable and should be done in one of an institution's approved color schemes. Placement options are as follows:

- Front Chest Left
- Front Chest Right
- Front Chest Middle
- Left Front Short
- Right Front Short

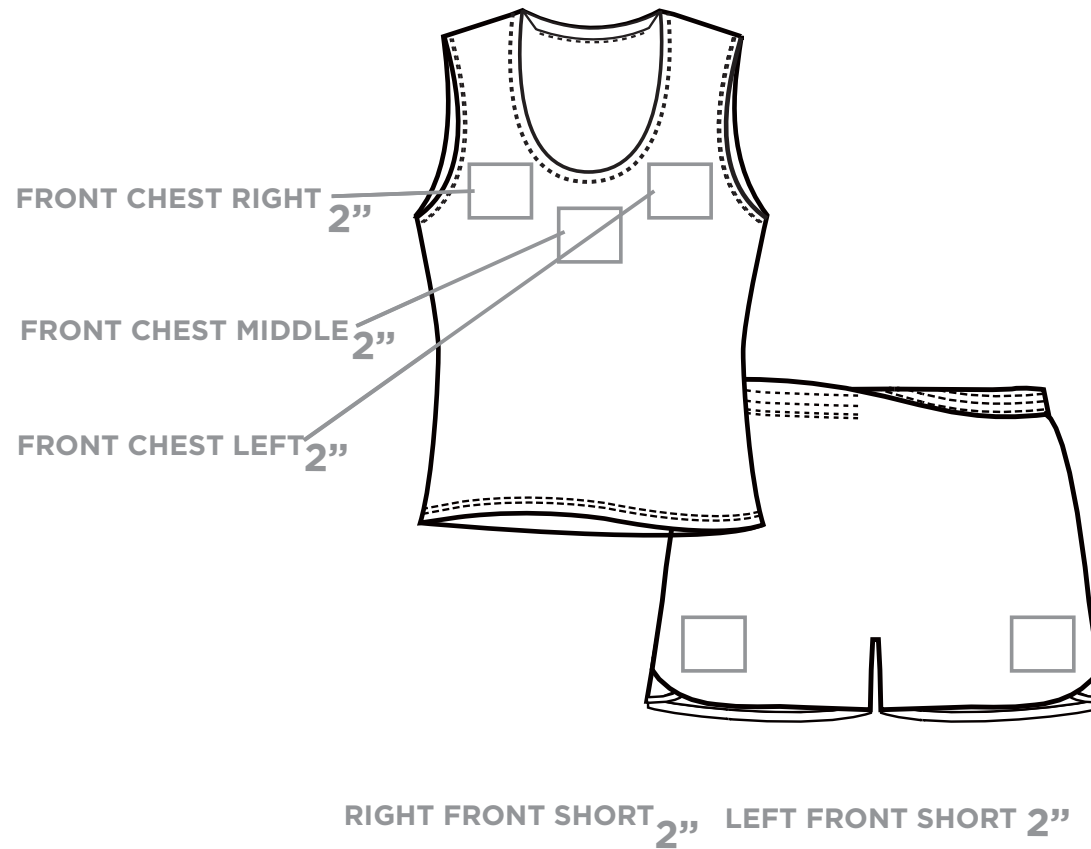

UNIFORM & APPAREL PATCH PLACEMENT - SOCCER

Due to varying uniform types for Soccer, either an SEC uniform patch or SEC full color screen print mark is acceptable and should be done in one of an institution's approved color schemes. Placement options are as follows:

- Front Chest Left
- Front Chest Right
- Front Chest Middle
- Left Sleeve
- Right Sleeve
- Left Front Short
- Right Front Short

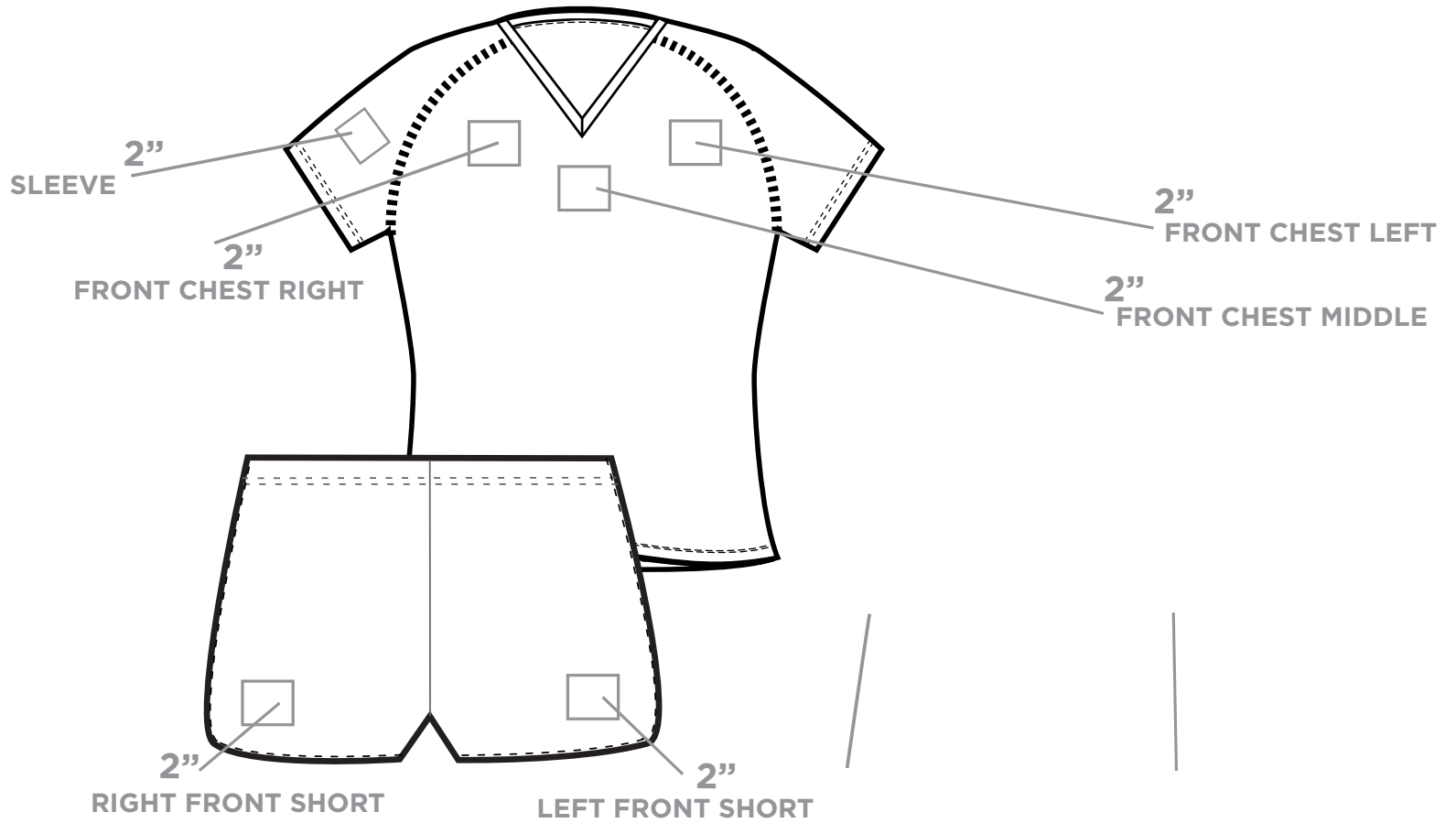

T

UNIFORM & APPAREL PATCH PLACEMENT - VOLLEYBALL

Due to varying uniform types for Volleyball, either an SEC uniform patch or SEC full color screen print mark is acceptable and should be done in one of an institution's approved color schemes. Placement options are as follows:

- Front Chest Left
- Front Chest Right
- Front Chest Middle
- Left/Right Sleeve
- Left Front Short
- Right Front Short

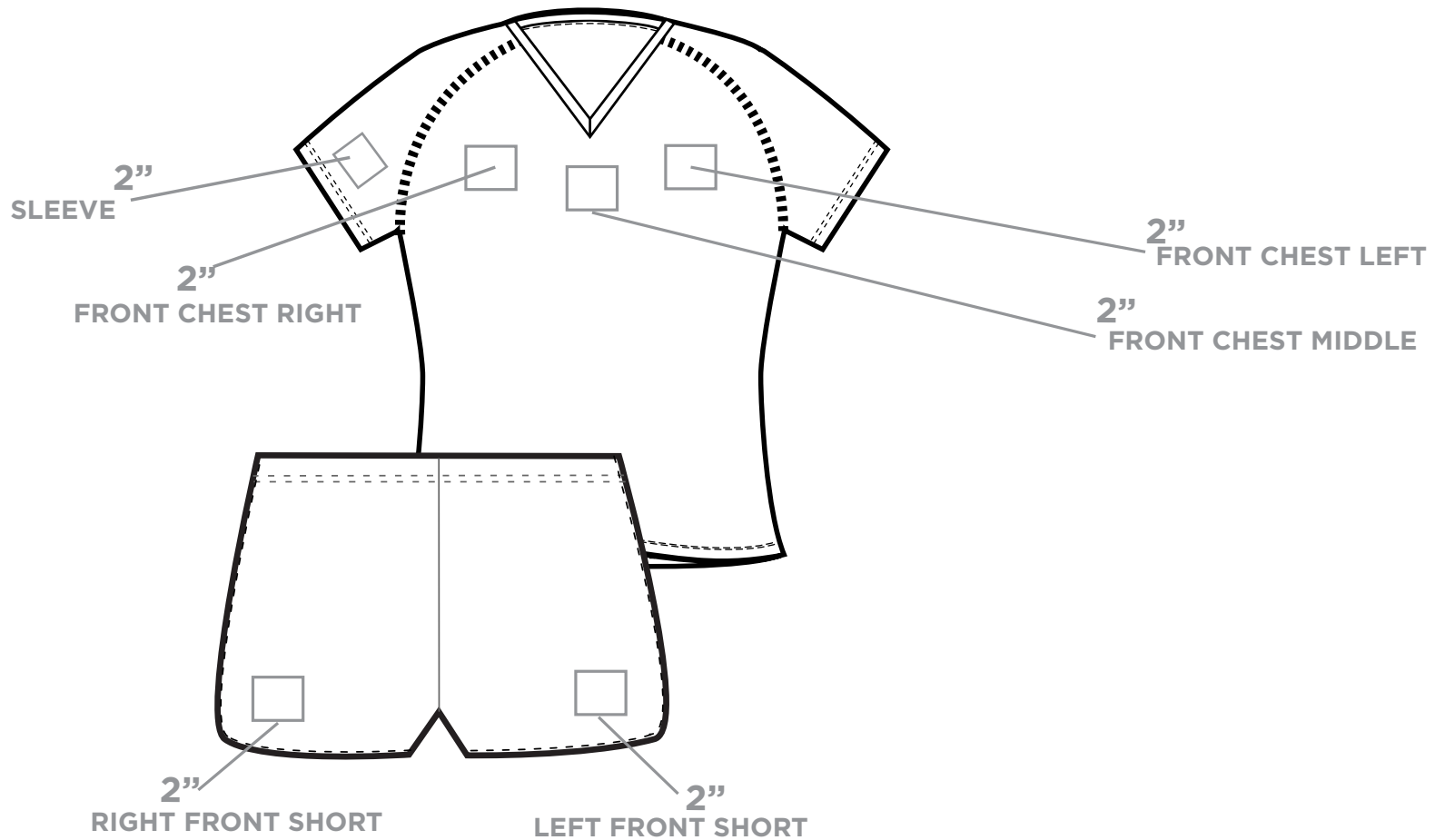

UNIFORM & APPAREL PATCH PLACEMENT - FOOTBALL

The SEC patch shall be used on the front of football jerseys. The size and placement options for the patches are:

1. 1.25" (in diameter) patch placed on the front-center collar of the jersey.
2. 2.5" (in diameter) patch placed on the front-left or right upper chest of the jersey.

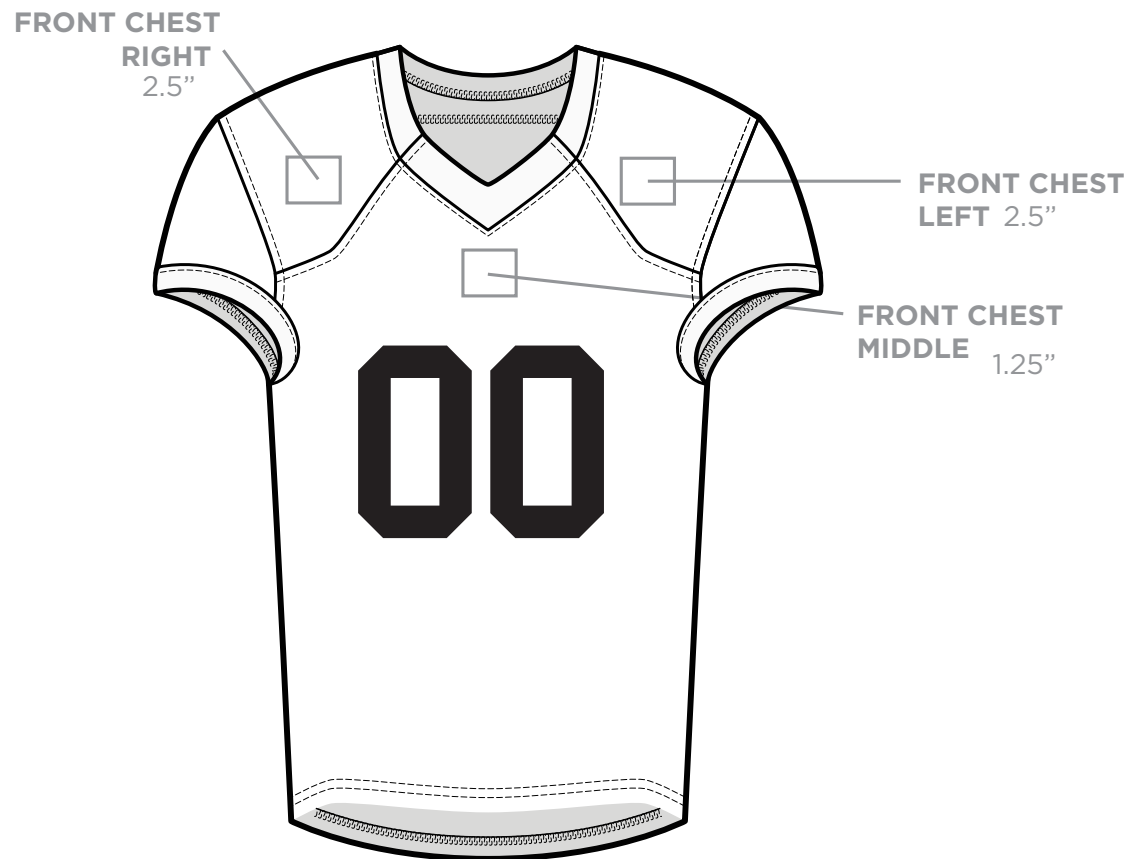

UNIFORM & APPAREL PATCH PLACEMENT - EQUESTRIAN

Due to varying uniform types for Equestrian (Hunt Seat and Western), either the SEC Uniform patch or SEC full color screen print mark is acceptable and should be done in an institution's approved color scheme. Placement options are as follows:

Hunt Seat

- Saddle Pad
- Lapel of Riding Jacket
- Pocket Flap of Riding Jacket
- Helmet

Western

- Saddle Pad
- Shirt Collar
- Back Upper Middle (back tag area)

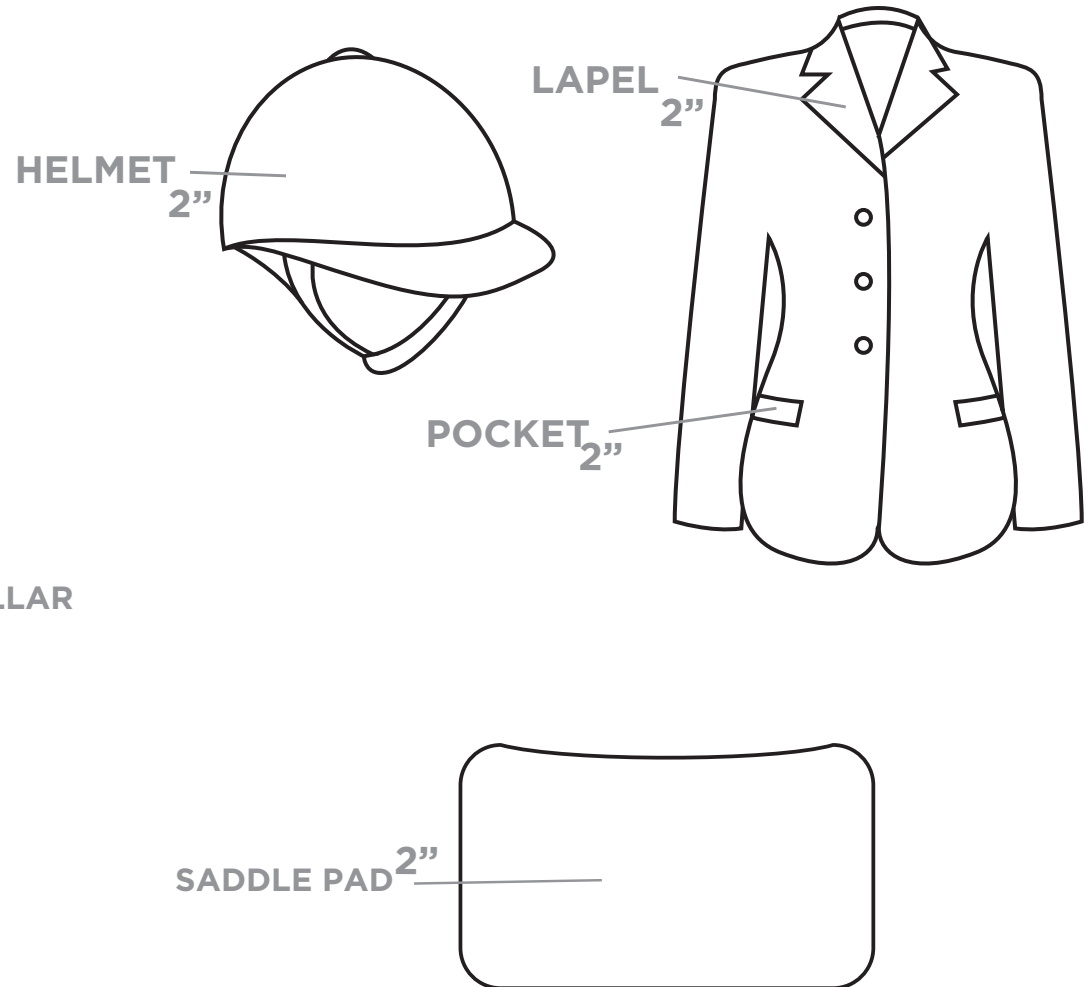

UNIFORM & APPAREL PATCH PLACEMENT - SWIMMING & DIVING

Due to varying uniform types for Swimming & Diving, either an SEC uniform patch or SEC full color screen print mark is acceptable and should be done in one of an institution's approved color schemes. Placement options are as follows:

- Front Swim Cap
- Side(s) Swim Cap
- Back Swim Cap
- Designated Official Warm-up Apparel (including parka)

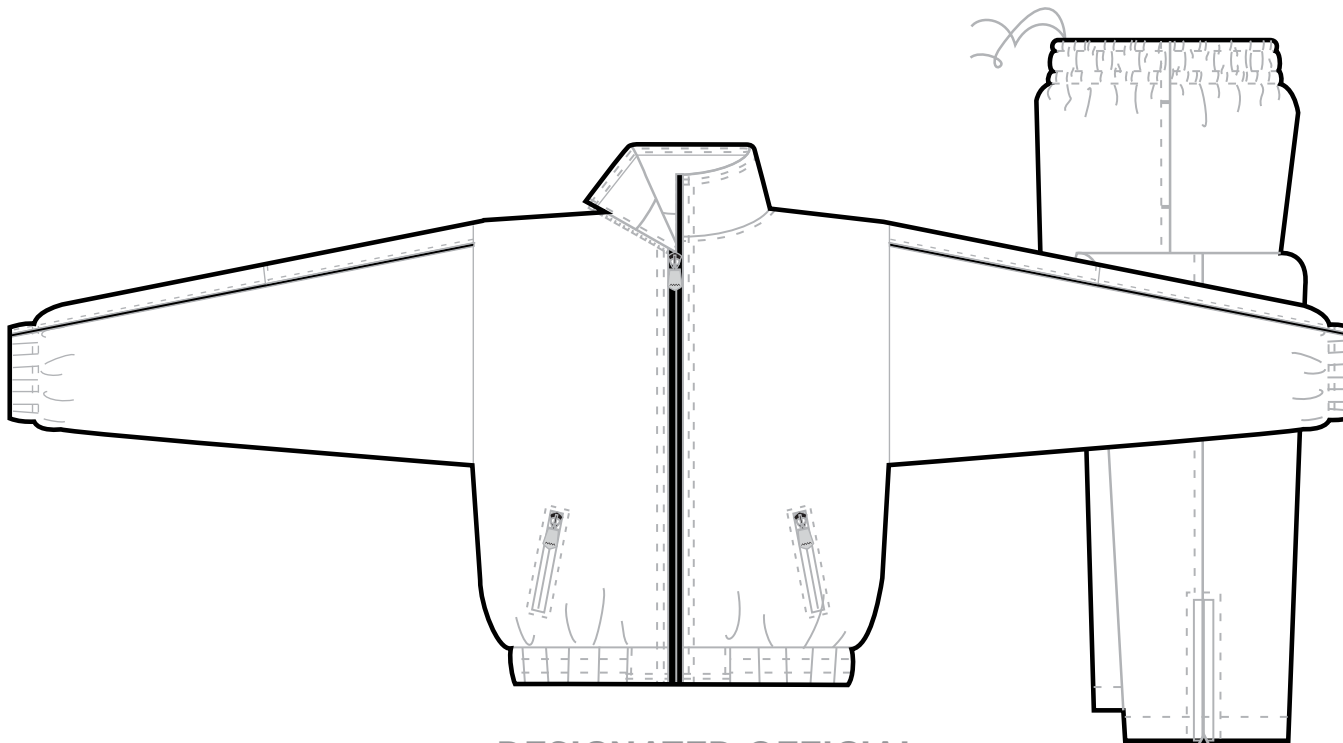
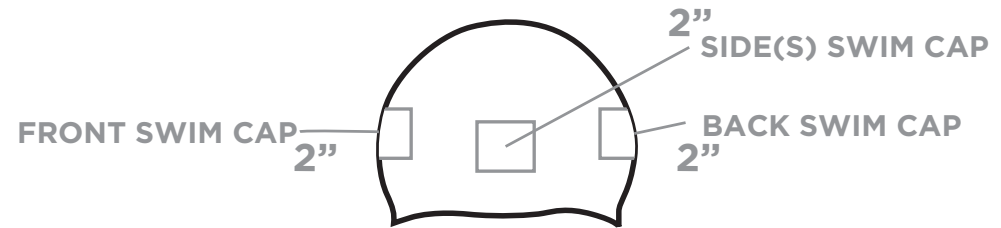

**DESIGNATED OFFICIAL
WARM-UP APPAREL**

UNIFORM & APPAREL PATCH PLACEMENT - BASKETBALL

Uniform patch to be worn on jersey above the number(s). Placement options are as follows:

- Front Chest Left
- Front Chest Right
- Front Chest Middle

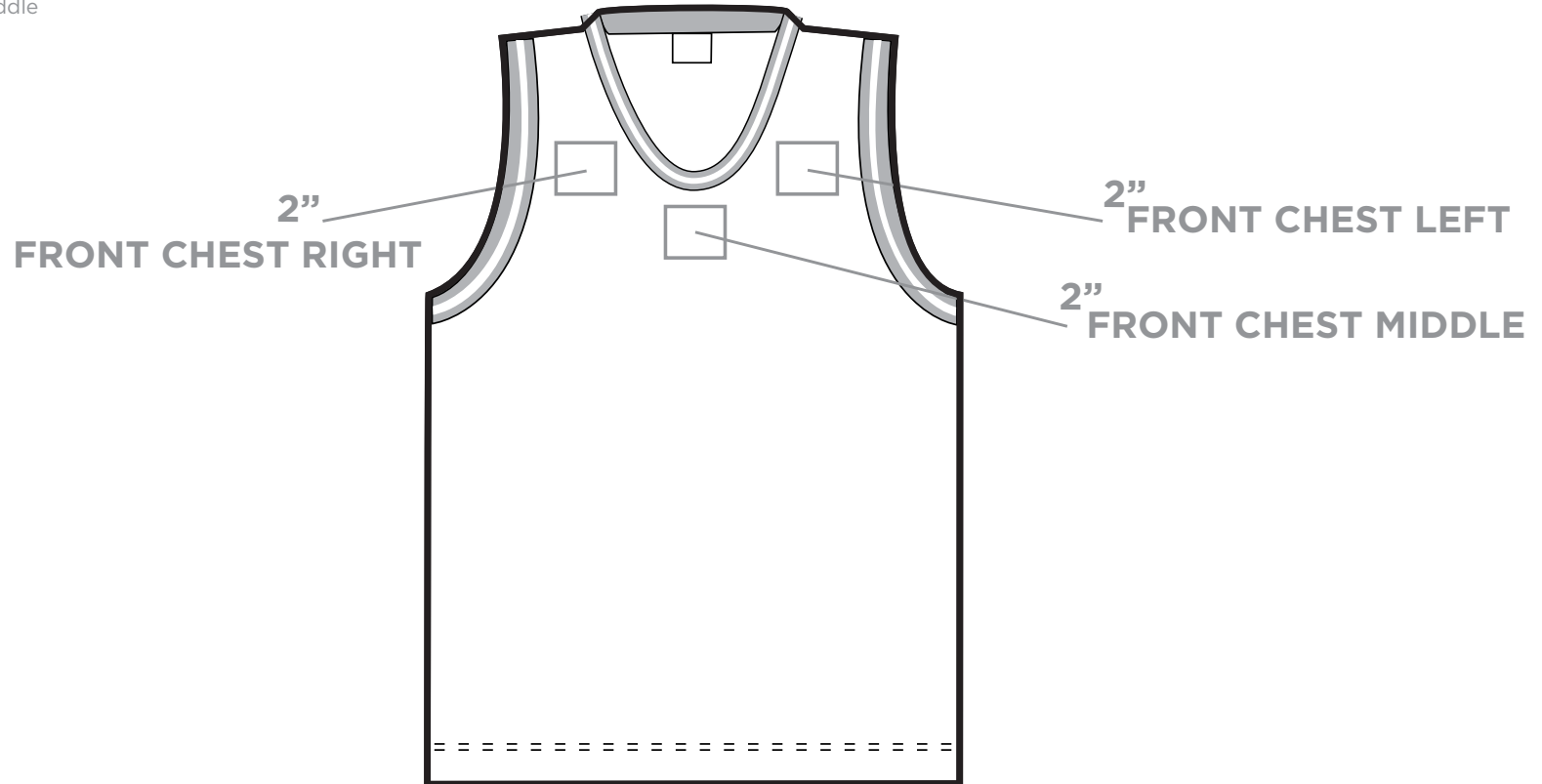

At the 2011 May Basketball Rules Committee Meeting, the NCAA Staff recommended that the current "optional" use of the authentication mark, manufacturers' mark and conference marks continue indefinitely as was in place in 2010-11. The guidelines for placement of the SEC Uniform Patch however remain as set forth in the SEC Brand Style Guide, which calls for the SEC patch to be placed on the front of the basketball jersey, above the numbers, and either on the left, center or right chest of the jersey. It is an institutional decision as to whether the NCAA Basketball patch and/ or manufacturer's marks are included on the uniforms (not required).

UNIFORM & APPAREL PATCH PLACEMENT - GYMNASTICS

Due to varying uniform types for Gymnastics, either an SEC uniform jewelled or bedazzled logo or SEC color screen print mark is acceptable and should be done in one of an institution's approved color schemes. Placement options are as follows:

- Designated Official Warm-up Apparel
- Backpack
- Leotard

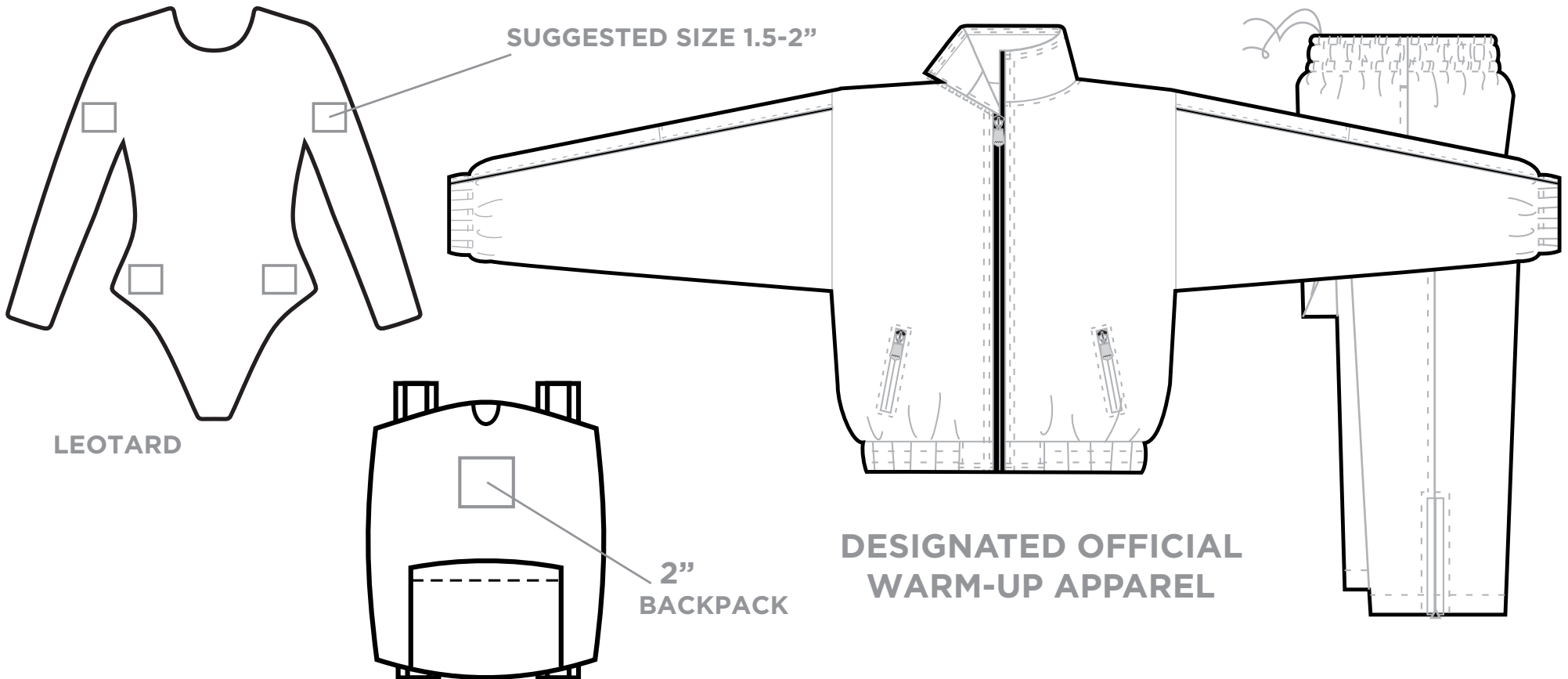

UNIFORM & APPAREL PATCH PLACEMENT - TENNIS

Due to varying uniform types for Tennis, either an SEC uniform patch or SEC full color screen print mark is acceptable and should be done in one of an institution's approved color schemes. Placement options are as follows:

- Left Sleeve
- Right Sleeve
- Left Front Short/Skirt
- Right Front Short/Skirt

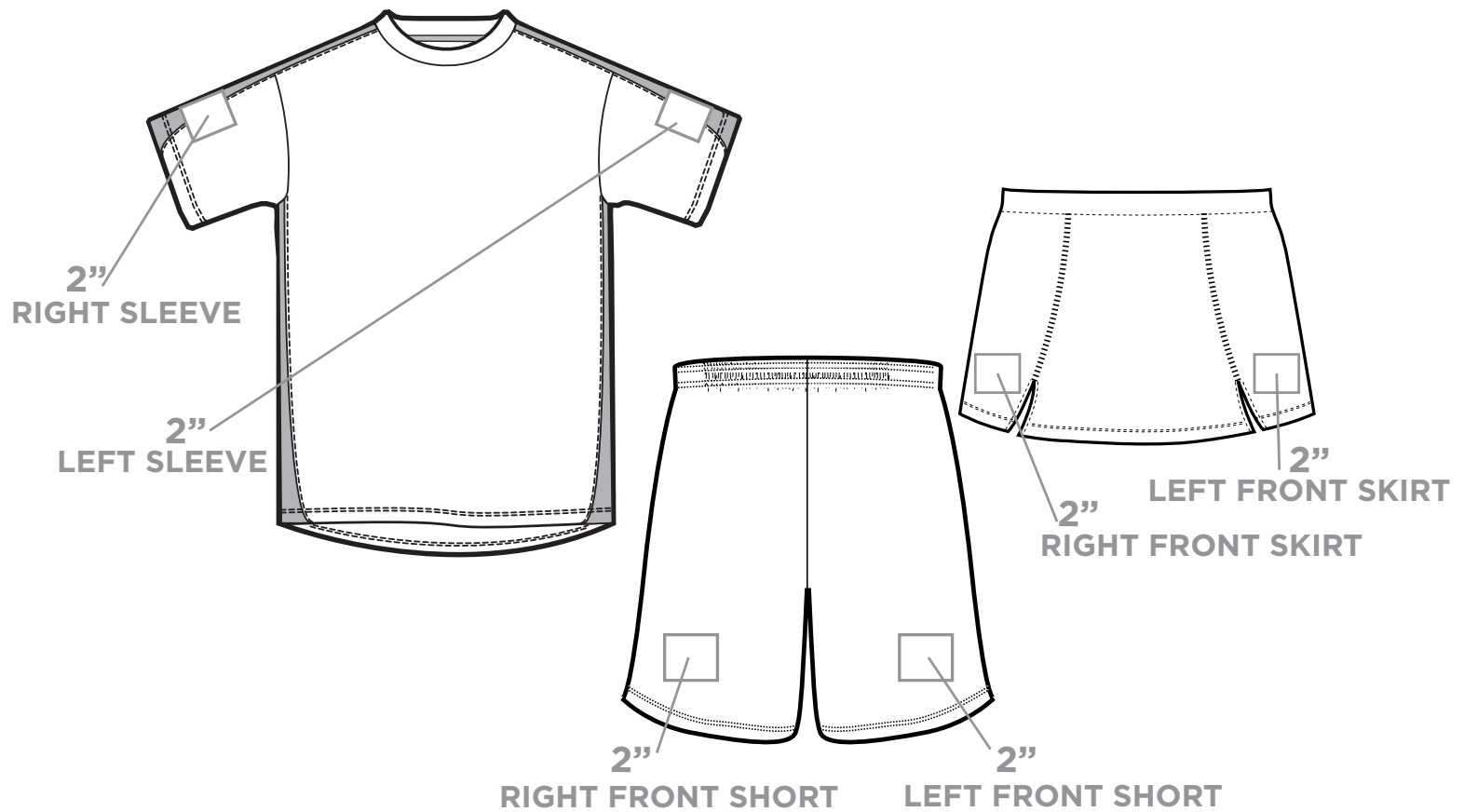

UNIFORM & APPAREL PATCH PLACEMENT - GOLF

Due to varying uniform types for Golf, either an SEC uniform patch or SEC full color screen print mark is acceptable and should be done in one of an institution's approved color schemes. Placement options are as follows:

- Front Chest Left
- Front Chest Right
- Front Chest Middle
- Left Sleeve
- Right Sleeve
- Golf Bag

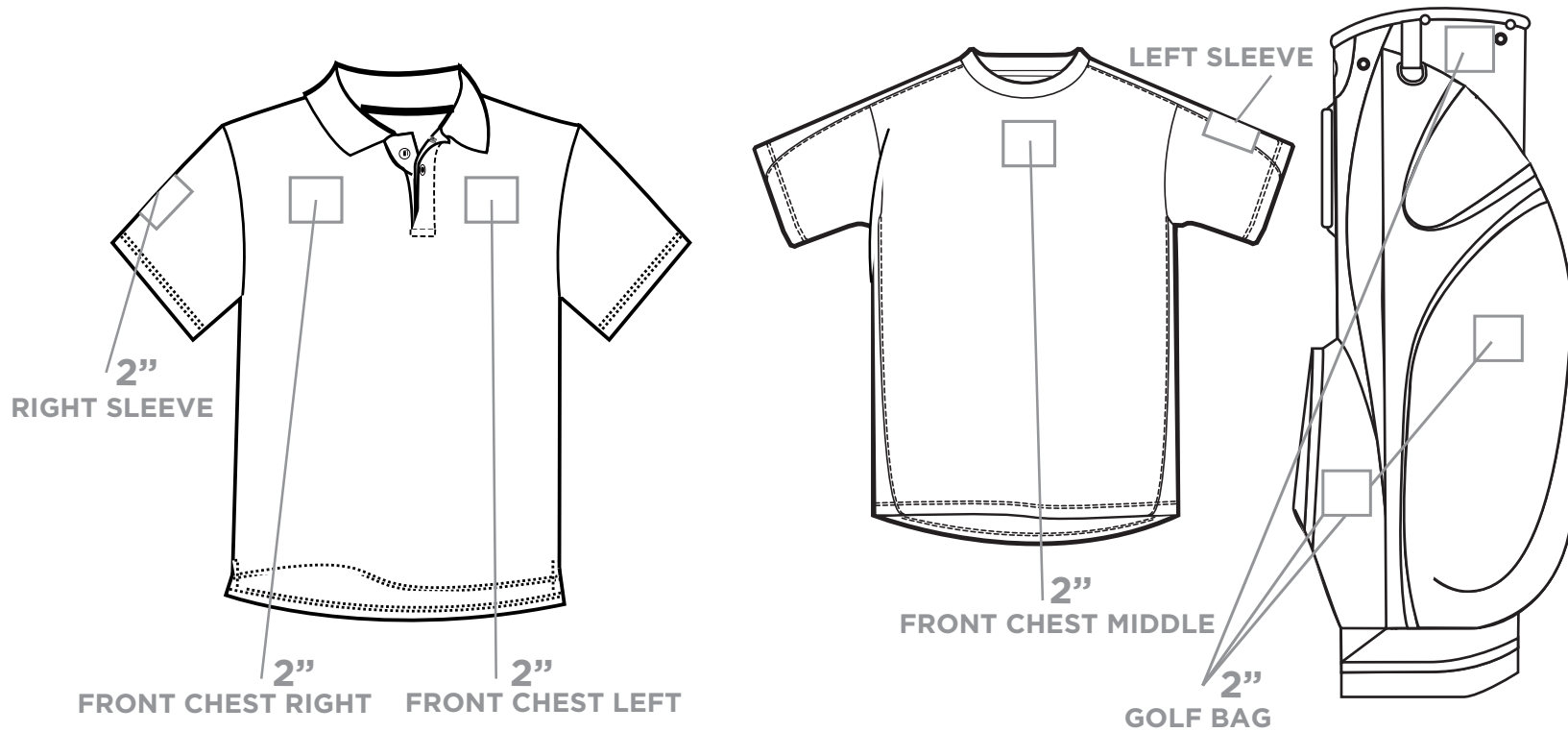

UNIFORM & APPAREL PATCH PLACEMENT - BASEBALL/SOFTBALL

Uniform patch to be worn on jersey. Placement options are as follows:

- Front Chest Left
- Front Chest Right
- Left Sleeve
- Right Sleeve



PLAYING SURFACE LOGO PLACEMENT OVERVIEW



This section of the style guide should assist member institutions with placement of the SEC logo on all competition surfaces and in all competition venues. Each institution should utilize the SEC primary logo in its approved school colors. Detailed information about acceptable SEC school color marks, including PMS colors, may be found on page 8 of this style guide.

World Class Athletic Surfaces has previously provided each institution with an SEC logo field stencil (15' x 15') for use in outdoor venues. Each institution should paint the SEC logo (in approved institutional colors) on fields in accordance with the placement guidelines outlined herein. Questions regarding the stencil or paint should be directed to World Class Athletic Surfaces. The contact at World Class Athletic Surfaces is:

Mike Williams
662.210.0035
mike@worldclasspaints.com

CSE Sports can produce SEC signage specific to each institution. Please contact CSE Sports directly with the measurements of any SEC signage needed (signage will be billed to the SEC upon approval). The contact at CSE Sports is:

Rob Thomas
205.908.7446
rthomas@signexp.com

SOCCER

Logos painted in school approved colors on field.



PLAYING SURFACE LOGO PLACEMENT - VOLLEYBALL

VOLLEYBALL

Logos applied in school approved colors on court.

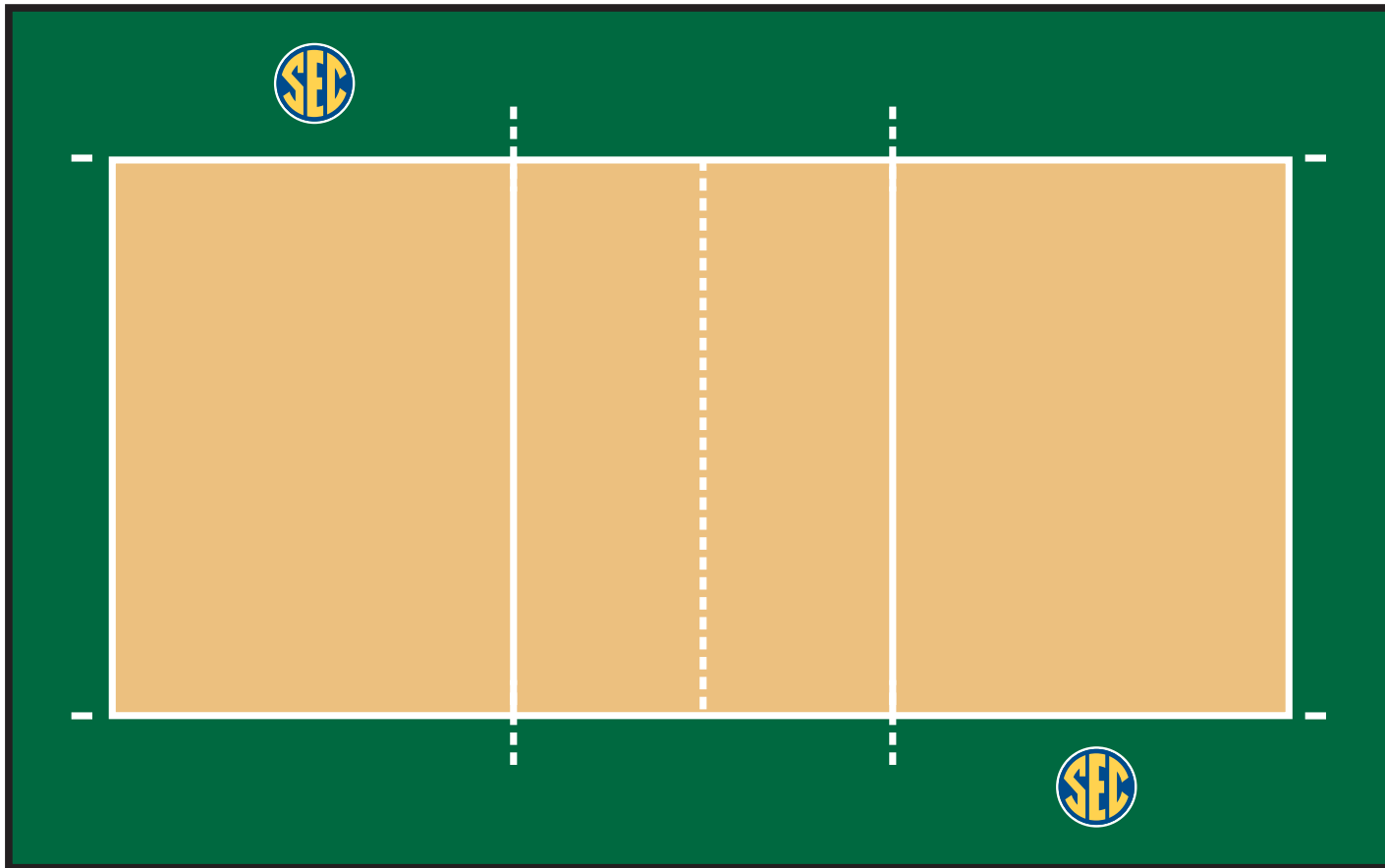

PLAYING SURFACE LOGO PLACEMENT - FOOTBALL

FOOTBALL

Logos painted in school approved colors on field between the numbers and hash marks. The logos should be painted diagonally from each other facing the press box (TV Cameras) on either the 25 or 35 yard line. Please note that any field logo must not completely obliterate a yard line.

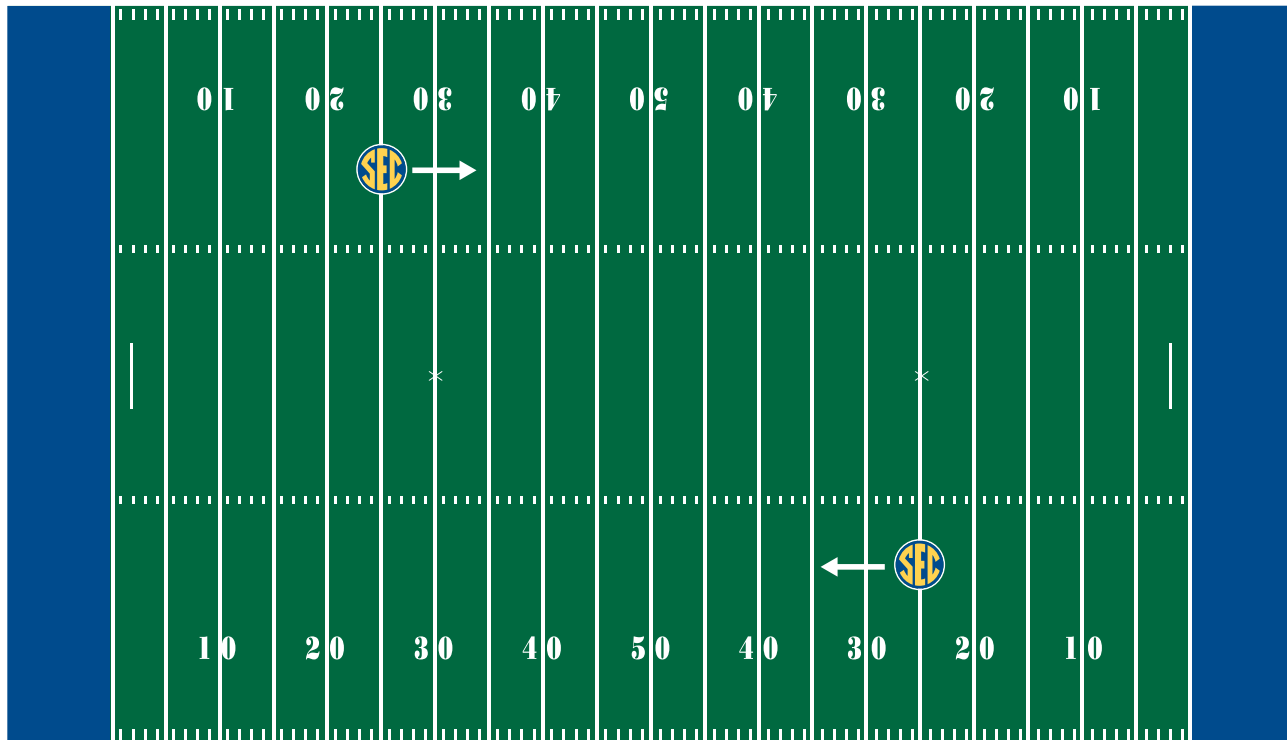

PLAYING SURFACE LOGO PLACEMENT - BASKETBALL

BASKETBALL

Logos to be applied in school colors or applicable floor matching color inside both free throw lanes facing the shooter.

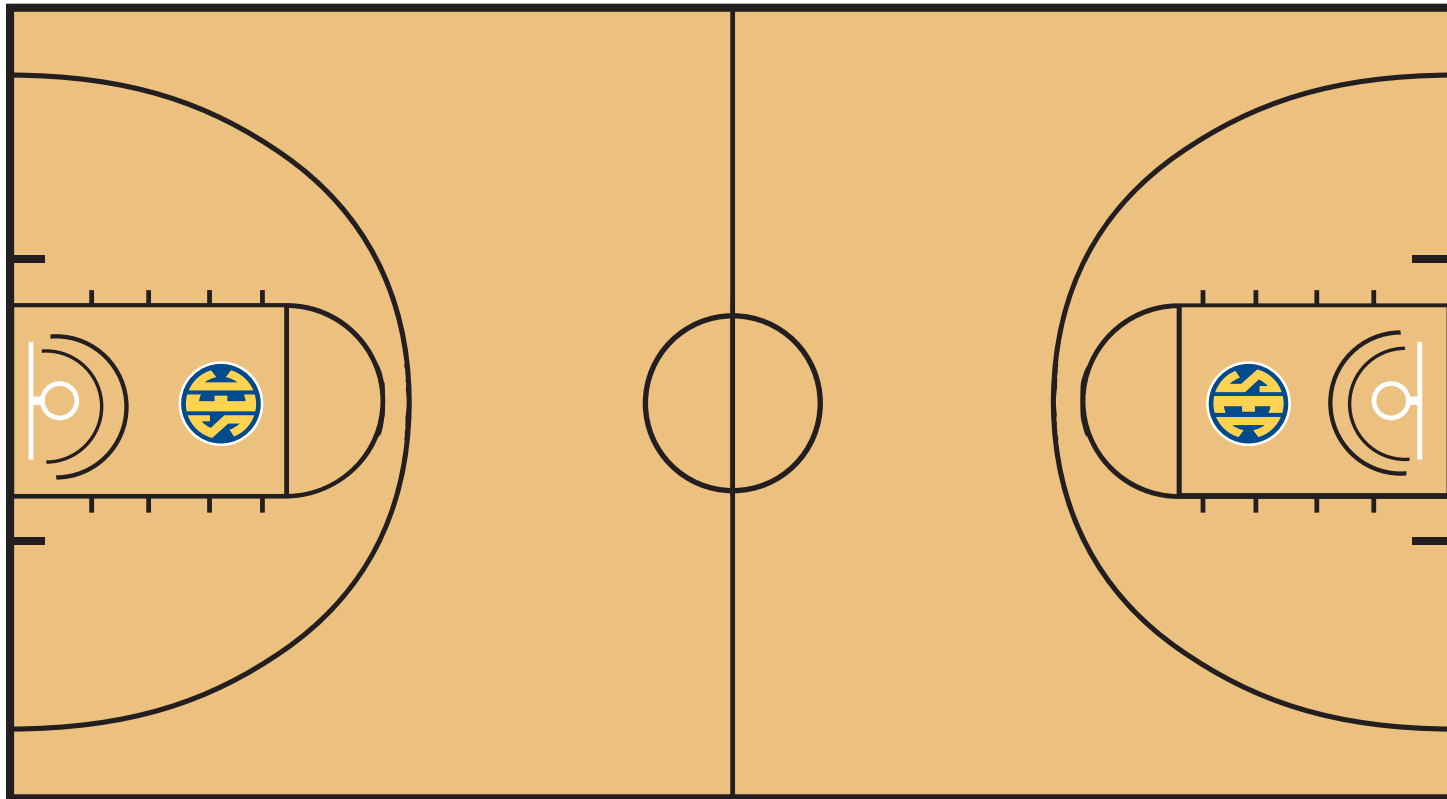

BASEBALL/SOFTBALL

Logos placed in school approved colors either on field, on backstop padding, or on interior outfield walls.

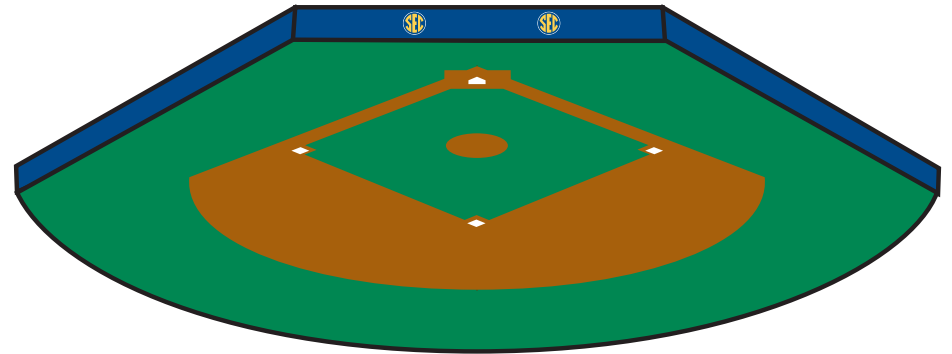
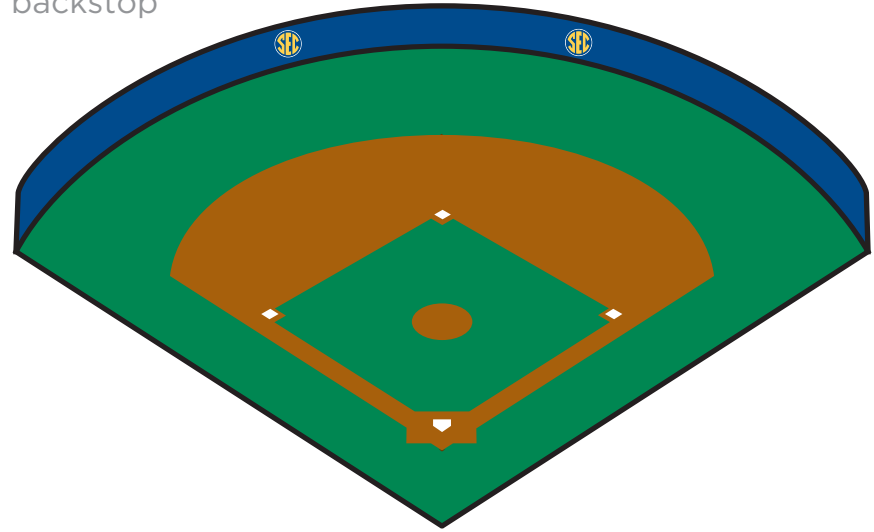
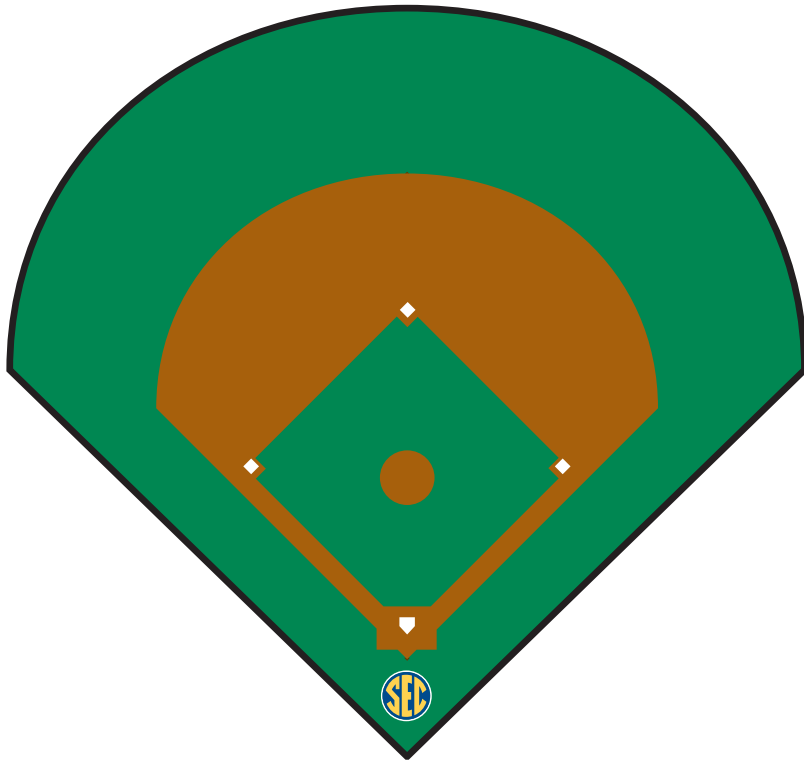

PLAYING SURFACE LOGO PLACEMENT - ALL OTHER SPORTS

CROSS-COUNTRY

- Logo painted in appropriate area (near start and/or finish) or minimum of two banners

EQUESTRIAN

- Logo painted in appropriate area or minimum of two banners in venue

SWIMMING & DIVING

- Minimum of two banners in venue

GYMNASTICS

- Minimum of two banners in venue

GOLF

- Logo painted in appropriate area or minimum of two banners in venue

TENNIS

- Minimum of two banners in venue

TRACK AND FIELD

- Logo painted on infield or minimum of two banners in venue

For questions or additional information regarding the SEC and its marks, please contact Charlie Hussey or Lauren Taylor:

Southeastern Conference

2201 Richard Arrington Blvd. North

Birmingham, AL 35203

P 205.458.3000

F 205.458.3031



INSTITUTIONAL MARKS

ALABAMA

PANTONE 201 C

PANTONE 428 C



ON LIGHT

ON DARK

ON CRIMSON

ON INTERMEDIATE

ONE COLOR



ON LIGHT

ON CRIMSON



INSTITUTIONAL MARKS

ARKANSAS

PANTONE 201 C

PANTONE 447 C

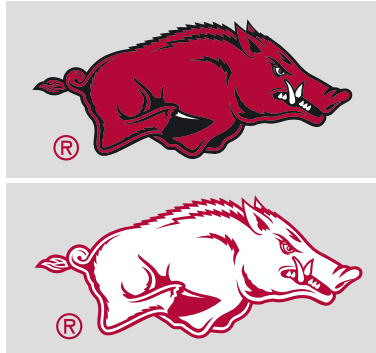

ON LIGHT



ON DARK



ON CRIMSON

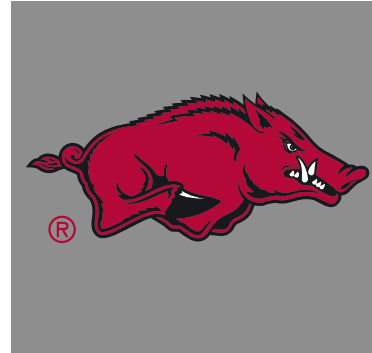

ON INTERMEDIATE

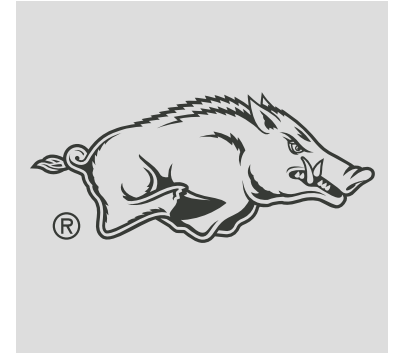

ONE COLOR



ON LIGHT



ON CRIMSON



BASEBALL/SOFTBALL



INSTITUTIONAL MARKS

AUBURN

PANTONE 289

PANTONE 172



ON LIGHT



ON DARK



ON ORANGE



ON INTERMEDIATE



ONE COLOR



ON LIGHT



ON BLUE



INSTITUTIONAL MARKS

FLORIDA

PANTONE 287 C

PANTONE 172 C

PANTONE 349 C



ON LIGHT

ON DARK

ON BLUE/ORANGE

ON INTERMEDIATE

ONE COLOR



ON LIGHT

ON BLUE



BASEBALL/SOFTBALL



INSTITUTIONAL MARKS

GEORGIA

PANTONE 200 C



ON LIGHT



ON DARK



ON RED



ON INTERMEDIATE



ONE COLOR



ON LIGHT



ON BLACK



INSTITUTIONAL MARKS

KENTUCKY

PANTONE 286 C

COOL GREY 3 C



ON LIGHT



ON DARK



ON BLUE



ON INTERMEDIATE



ONE COLOR



ON LIGHT



ON BLACK



INSTITUTIONAL MARKS

LSU

PANTONE 268 C

PANTONE 123 C



ON LIGHT



ON DARK



ON PURPLE/GOLD



ON INTERMEDIATE



ONE COLOR



ON LIGHT



ON PURPLE

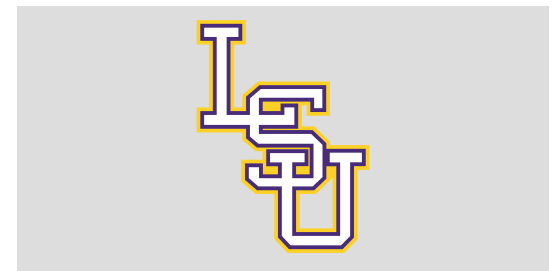

BASEBALL



INSTITUTIONAL MARKS

OLE MISS

PANTONE 186 C

PANTONE 281 C



ON LIGHT



ON DARK



ON RED/BLUE



ON INTERMEDIATE



ONE COLOR



ON LIGHT



ON BLUE



BASEBALL



INSTITUTIONAL MARKS

MISSISSIPPI STATE

PANTONE 505 C

PANTONE 428 C



ON LIGHT

ON DARK

ON MAROON

ON INTERMEDIATE

ONE COLOR



ON LIGHT

ON MAROON



BASEBALL



INSTITUTIONAL MARKS

MISSOURI

PANTONE 124 C



ON LIGHT



ON DARK



ON GOLD



ON INTERMEDIATE



ONE COLOR



ON LIGHT



ON BLACK



BASEBALL



INSTITUTIONAL MARKS

SOUTH CAROLINA

PANTONE 202 C



ON LIGHT

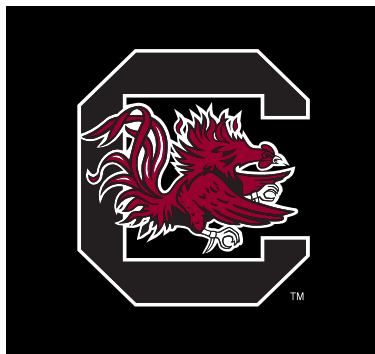

ON DARK



ON GARNET



ON INTERMEDIATE

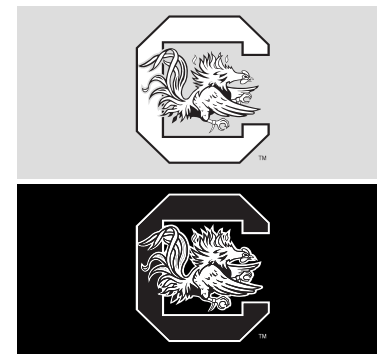

ONE COLOR



ON LIGHT



ON BLACK



BASEBALL/SOFTBALL



INSTITUTIONAL MARKS

TENNESSEE

PANTONE 200 C

COOL GRAY 11 C

PANTONE PROCESS BLUE C

*Lady Vols mark used only in the following sports: Women's Basketball, Women's Golf, Rowing, Softball, Women's Tennis and Volleyball



ON DARK

ON ORANGE

ON INTERMEDIATE

ONE COLOR



ON LIGHT

ON ORANGE



INSTITUTIONAL MARKS

TEXAS A&M

PANTONE AGGIE MAROON

PANTONE 422 C

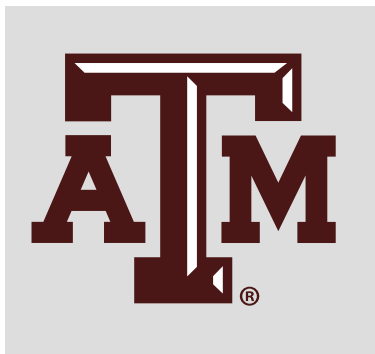

ON LIGHT



ON DARK



ON MAROON



ON INTERMEDIATE

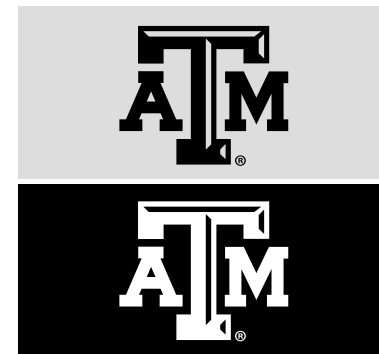

ONE COLOR



ON LIGHT



ON MAROON



INSTITUTIONAL MARKS

VANDERBILT

PANTONE 7502 C



ON LIGHT



ON DARK



ON GOLD



ON INTERMEDIATE

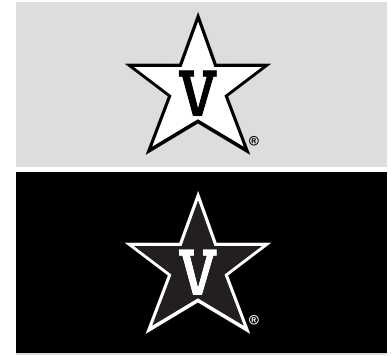

ONE COLOR



ON LIGHT



ON BLACK



BASEBALL